



# Product Catalogue



# Table of Contents

<b>Why Choose NTI?</b>	<b>2</b>
<b>Benefits of NTI Windows</b>	<b>3</b>
<b>Profile Characteristics</b>	<b>4</b>
<b>Customize Your Window</b>	<b>5</b>
<b>Colour Selection</b>	<b>6</b>
<b>Trim Profiles</b>	<b>7</b>
<b>Casement Windows</b>	<b>8</b>
<b>Awning Windows</b>	<b>9</b>
<b>Hung Windows</b>	<b>10</b>
<b>Slider Windows</b>	<b>11</b>
<b>Tilt &amp; Turn Windows</b>	<b>12</b>
<b>Bay &amp; Bow Windows</b>	<b>13</b>
<b>Door Components</b>	<b>14</b>
<b>Door Glass Options</b>	<b>15-23</b>
<b>Door Glass Frames</b>	<b>25</b>
<b>Executive Panels</b>	<b>26</b>
<b>Steel Slabs</b>	<b>27-28</b>
<b>Smooth Fiberglass Slabs</b>	<b>29</b>
<b>Fiberglass Slabs</b>	<b>30</b>
<b>Mahogany Grain Fiberglass Slabs</b>	<b>31</b>
<b>Oak Grain Fiberglass Slabs</b>	<b>32</b>
<b>Door Hardware</b>	<b>33</b>
<b>Patio Doors</b>	<b>34</b>
<b>Tilt &amp; Turn Patio Doors</b>	<b>35</b>
<b>Multi Track Patio Doors</b>	<b>36</b>
<b>Garage Doors</b>	<b>37-39</b>



# Why Choose NTI?



We remove the pressure and sales tactics from this important investment, managing every detail to meet our standards of quality craftsmanship and energy efficiency. NTI is raising the bar for customer service, quality, and transparency in the windows and doors industry, helping you maximize your investment and save money both now and over time.

Durable performance. Industry-leading low replacement rates.

Unrivaled strength. Our products are crafted from our exclusive, high-quality PVC with optimized profile designs, ensuring maximum impact resistance for a lifetime.

Weather-resistant. Our PVC windows and doors resist yellowing or fading, keeping their like-new appearance year after year.

Effortless usability. Built with durability and smart design in mind, our doors and windows offer a satisfying, lifetime use that customers truly enjoy.

NTI windows set the standard for energy efficiency, featuring thick internal and external profile walls for optimal insulation. These all-PVC windows combine exceptional performance with stylish designs, making them a top-tier choice across the board.



# Profile Characteristics

## CC Frame

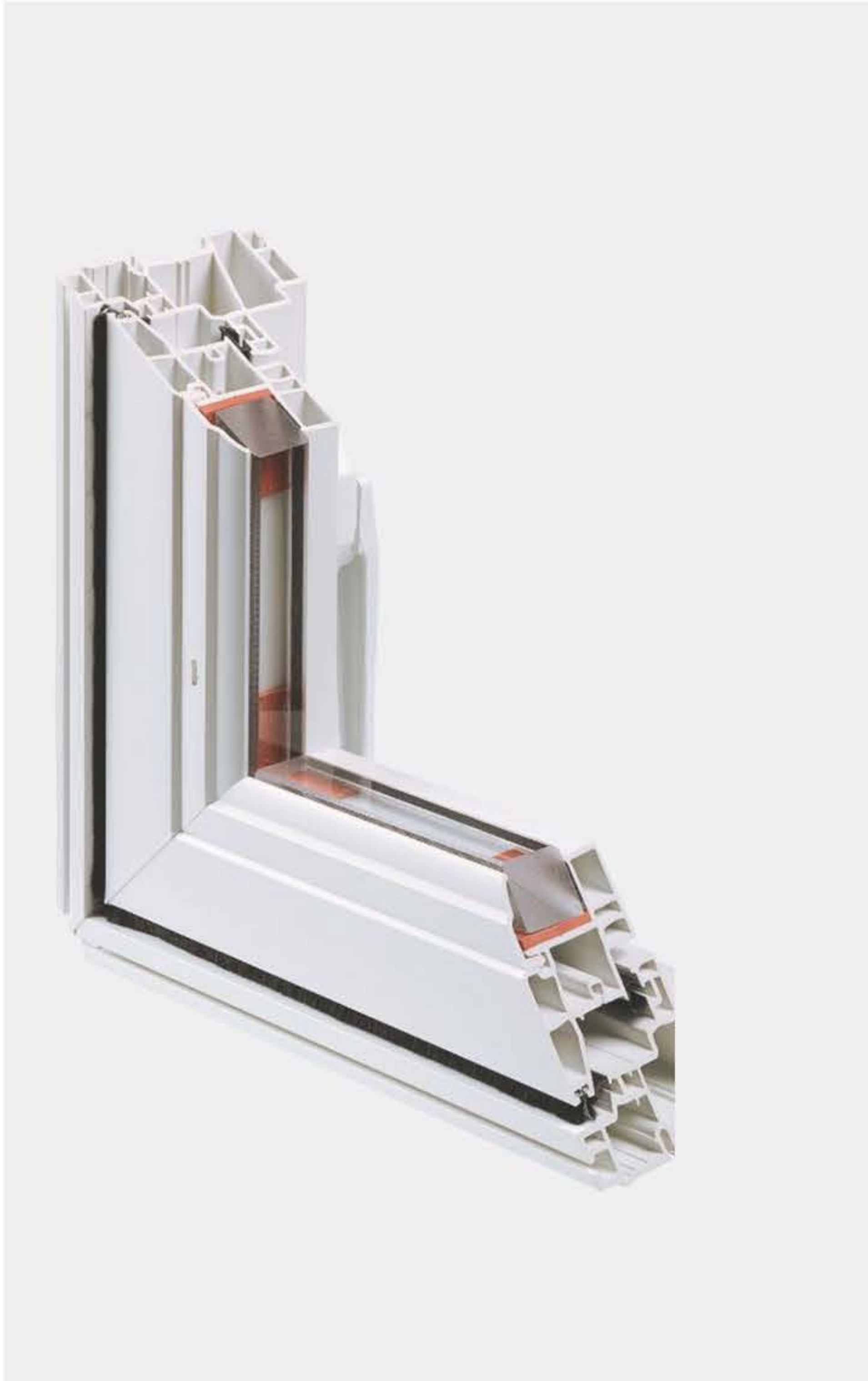

Where quality meets affordability.

NTI Windows offer streamlined designs without sacrificing performance or durability.

For budget-conscious customers, these windows deliver exceptional value.

## 416 Frame



NTI windows feature unmatched, Robust profiles that deliver exceptional wind resistance and superior air and water tightness.

Made from durable PVC that won't dry out or deteriorate, along with resilient hardware, these windows are built to withstand impact and last over time.

## TNT Frame



Exceptional performance and energy efficiency—NTI's TNT windows combine a modern European aesthetic with a versatile tilt-and-turn opening system that provides superior ventilation, energy savings, and thermal control.

Built with durable designs, they offer outstanding security against break-ins and complete protection from rain intrusion.



# Benefits of **NTI Windows**



## **Save on the cost of energy**

The average Canadian household consumes 1,000 kWh at around \$0.192 per kWh, our clients tell us they save anywhere from 20%-40% on their bills after installing our windows. That's a free car payment a year for most.



## **Security**

All our windows are built with enhanced security features and profiles that exceed industry standards.



## **Property value**

Not only do we help you save money, but the added curb appeal of your home also delivers a greater return on investment than expected.

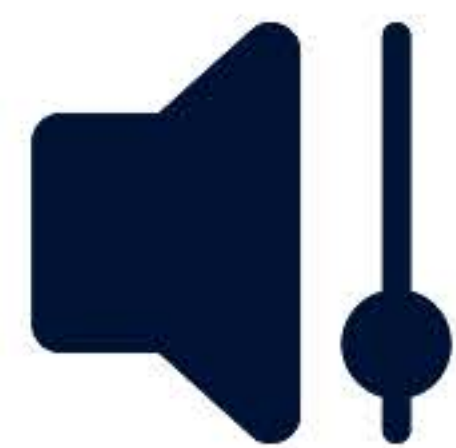

## **Increased comfort & noise reduction**

You'll enjoy a comfortable indoor temperature without straining your air conditioner or heater, plus the added benefit of superior sound insulation from your new NTI windows.



## **Certification**

We are NAFS Tested/Certified in addition to Energy Star. Our products meet and exceed industry standards.



# Customize **Your** Window

## Brickmould & Trim Options

A wide variety of decorative brickmoulds, drywall returns, jamb extensions and trim options are available to finish the window. Most brickmoulds have tear-out systems to allow for siding. Available in standard white, these extrusions can be painted to match your chosen window frame colour.



## Screens

Our screens are smooth, clean and tidy. Screen retention systems built into the corners, leaving a sleek profile.



## Window Patterns

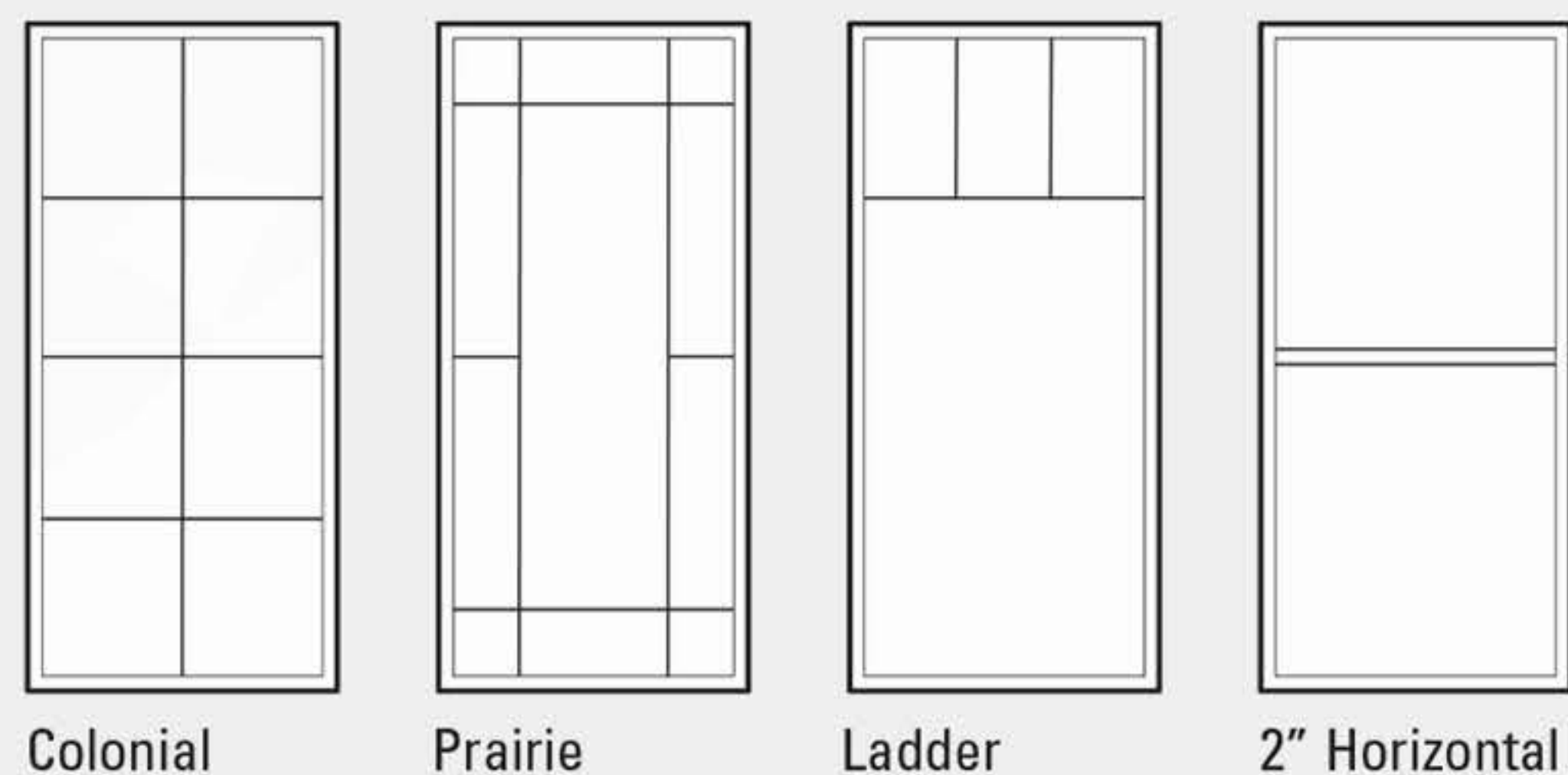

## Functionally Artistic Hardware



## Contemporary Hardware Options





# Colour Selection





# Trim Profiles

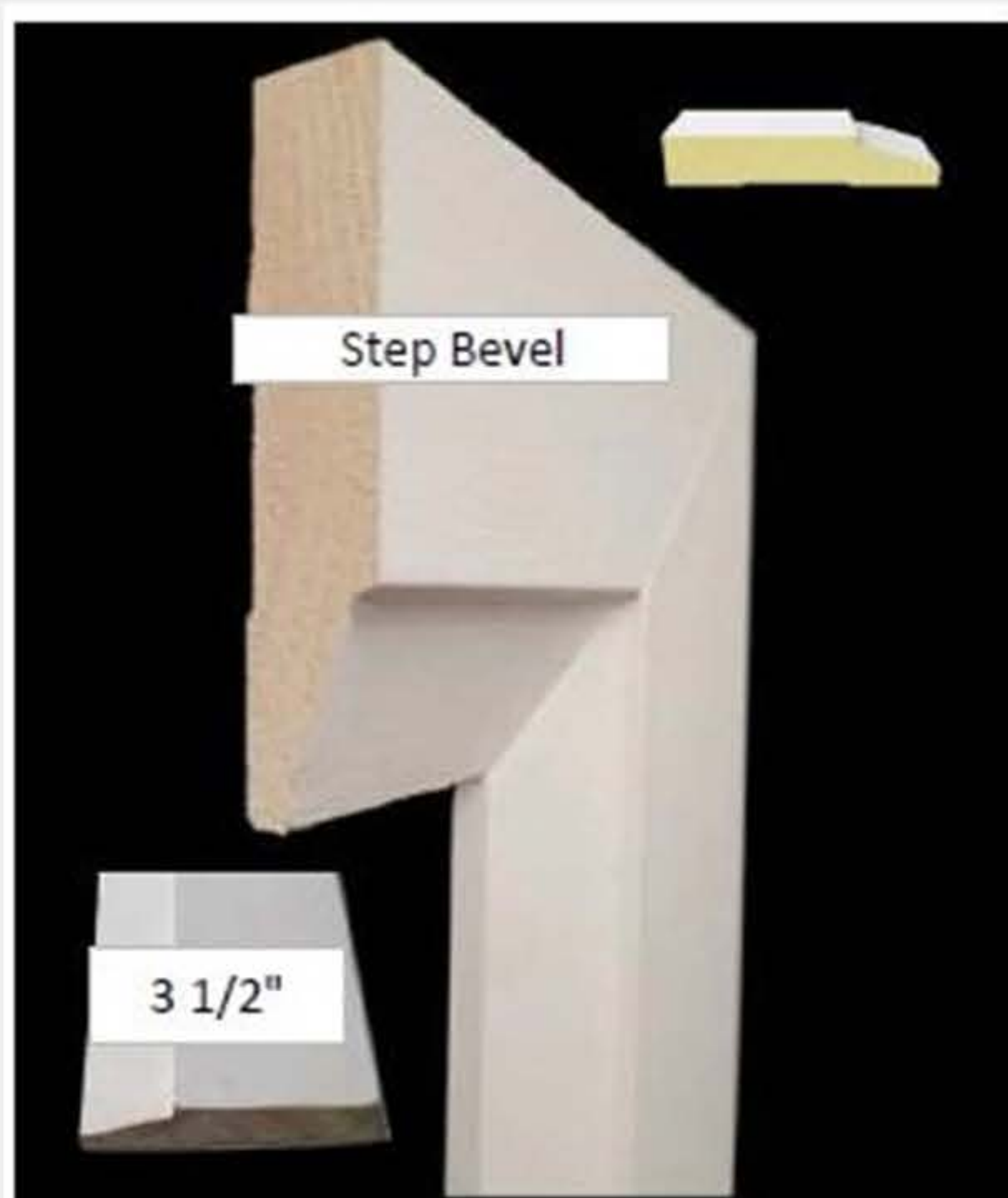
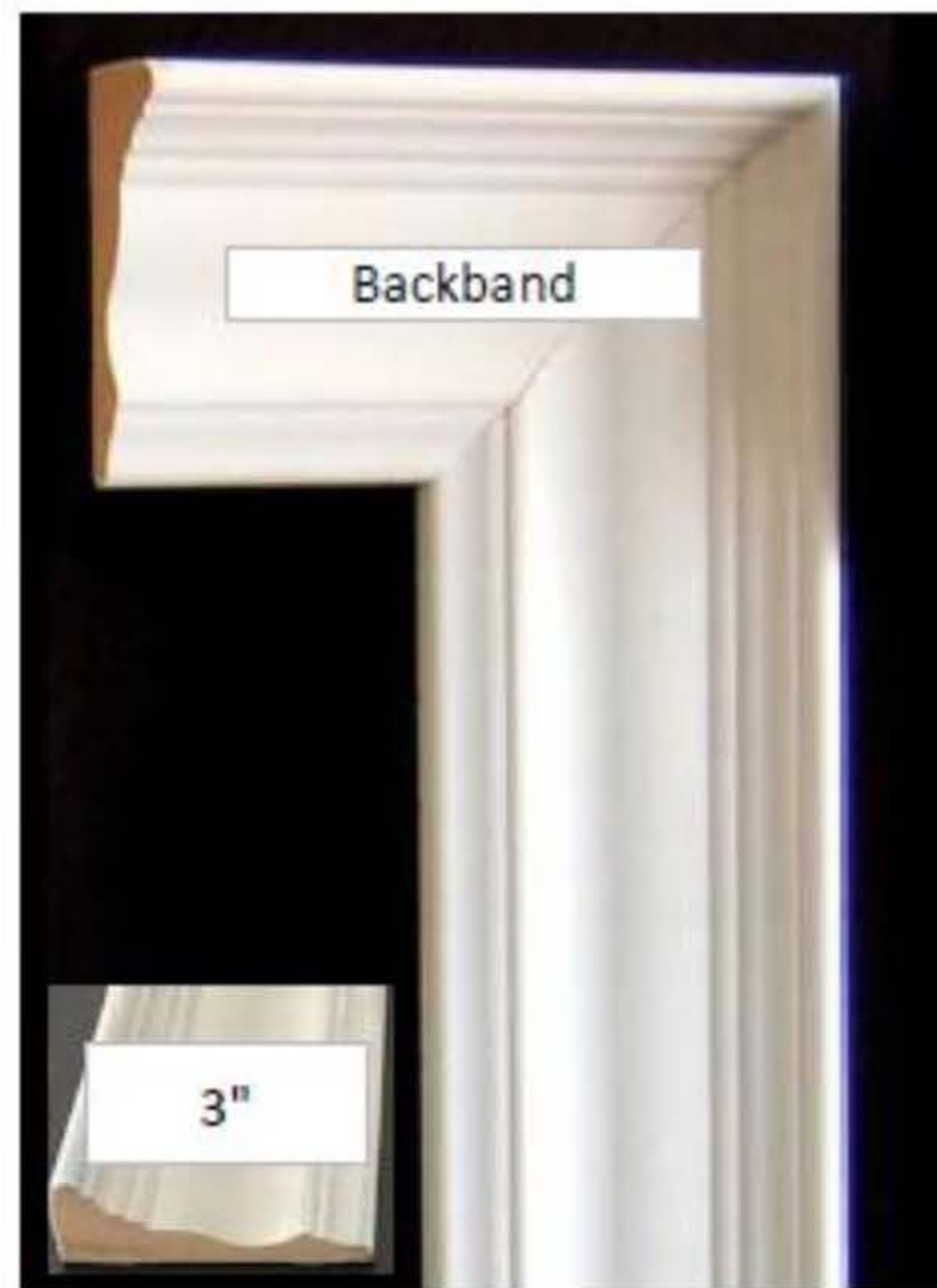



# Casement Windows

## Product Description

NTI's casement windows are crafted to endure all Canadian seasons. Each casement window features a sash that opens outward horizontally with multiple hinges and a multi-locking system for a secure, airtight seal. Our window frames are fusion-welded for maximum strength and durability with screens located on the inside for longevity and easy removal.

Casement windows open like doors. They are simple to operate, easy to clean and provide maximum air-flow. Awning windows are very similar in function and performance. They open from the bottom out to provide the added benefit of preventing rainfall entry. Both window styles are ideal for the variable Canadian climate, are CSA-A440 compliant and meet EnergyStar® requirements.



- Designed to make life easier, a casement sash opens a full 90° for easy cleaning
- Window operation is smooth, consistent, and effortless
- Strassburger casement and awning windows have outstanding insulation and sound abatement qualities, as well as excellent thermal efficiency and increased strength
- 100% uPVC extrusions are designed to provide superior resistance to severe weather conditions
- Stainless steel multi-point locking system provides heavy-duty security
- Triple weather-stripping keeps the elements out
- Available in a range of glass types and thicknesses including double and triple glazing
- Designed to be aesthetically & structurally compatible with other NTI window & door styles
- Operating hardware is available in several colours and optional finishes
- Standard extrusion colour is solid white. See colour chart for exterior standard and custom colours

3000 Series Casement

4000 Series Casement

- 1 Triple weather-stripping provides remarkable air tightness, reducing heating and air conditioning costs
- 2 Interior glazing bead design allows the window to withstand winds of over 350 km/h (220 mph)
- 3 With a single handle, our stainless steel multi-point locking bar is activated
- 4 Accommodates virtually all types of glazing
- 5 Fusion welded seams create a 100% water and airtight surface and increase the structural integrity of frames and sashes
- 6 Interior and exterior grooves allow for brickmoulds, nailing flanges, returns and jamb extensions
- 7 Strassburger windows have the highest number of internal chambers

Performance - Test Results				
	Air	Water	Wind	Forced Entry
Casement	A3	B7	C5	F2
Awning	A3	B7	C5	F2
Ind. Standard	A1	B1	C1	F1

Products tested to new NAFS standard (AAMA/WDMA/CSA101/I.S.S/A440-08)



### Performance

Easy to operate Truth Maxim hardware is designed to reduce air and water infiltration. Smooth functioning, durable mechanisms are concealed for a clean appearance.



### Security

Elegant handles and multi-point latches secure the windows at three points to provide not only superior protection from the elements but also protection from tampering and vandalism.



# Awning Windows

## Product Description

NTI awning windows are designed for durability to withstand Canada's four-season climate. As a versatile choice, they are hinged at the top and open outward from the bottom, providing excellent airflow and an unobstructed, panoramic view—offering the best of both functionality and aesthetics.

Casement windows open like doors. They are simple to operate, easy to clean and provide maximum airflow. Awning windows are very similar in function and performance. They open from the bottom out to provide the added benefit of preventing rainfall entry. Both window styles are ideal for the variable Canadian climate, are CSA-A440 compliant and meet EnergyStar® requirements.



- Designed to make life easier, a casement sash opens a full 90° for easy cleaning
- Window operation is smooth, consistent, and effortless
- Strassburger casement and awning windows have outstanding insulation and sound abatement qualities, as well as excellent thermal efficiency and increased strength
- 100% uPVC extrusions are designed to provide superior resistance to severe weather conditions
- Stainless steel multi-point locking system provides heavy-duty security
- Triple weather-stripping keeps the elements out
- Available in a range of glass types and thicknesses including double and triple glazing
- Designed to be aesthetically & structurally compatible with other NTI window & door styles
- Operating hardware is available in several colours and optional finishes
- Standard extrusion colour is solid white. See colour chart for exterior standard and custom colours



### Performance

Easy to operate Truth Maxim hardware is designed to reduce air and water infiltration. Smooth functioning, durable mechanisms are concealed for a clean appearance.



### Security

Elegant handles and multi-point latches secure the windows at three points to provide not only superior protection from the elements but also protection from tampering and vandalism.

3000 Series Casement

4000 Series Casement

- 1 Triple weather-stripping provides remarkable air tightness, reducing heating and air conditioning costs
- 2 Interior glazing bead design allows the window to withstand winds of over 350 km/h (220 mph)
- 3 With a single handle, our stainless steel multi-point locking bar is activated
- 4 Accommodates virtually all types of glazing
- 5 Fusion welded seams create a 100% water and airtight surface and increase the structural integrity of frames and sashes
- 6 Interior and exterior grooves allow for brickmoulds, nailing flanges, returns and jamb extensions
- 7 Strassburger windows have the highest number of internal chambers

Performance - Test Results				
	Air	Water	Wind	Forced Entry
Casement	A3	B7	C5	F2
Awning	A3	B7	C5	F2
Ind. Standard	A1	B1	C1	F1

Products tested to new NAFS standard (AAMA/WDMA/CSA101/I.S.S/A440-08)



# Hung Windows

## Product Description

NTI hung windows are available with single or double operating sashes, based on your preference, and open vertically for ventilation. They're an ideal choice for spaces near walkways, decks, fences, and porches. They are easy to clean as well.

A traditional looking window that's simple to operate and easy to clean. Single slider windows have one sash fixed while the other opens from side to side. Single hung windows have the top sash fixed in place while the bottom slides up and down and tilts in for easy cleaning. Both window styles offer superior ventilation control, are ideal for the variable Canadian climate and are CSA-A440 compliant and meet EnergyStar® requirements.



- Designed to make life easier, the single hung moveable sash tilts inward for easy cleaning.
- Window operation is smooth, consistent, and effortless
- NTI single slider and single hung windows have outstanding insulation and sound abatement qualities, as well as excellent thermal efficiency and increased strength
- 100% uPVC extrusions are designed to provide superior resistance to severe weather conditions
- Steel cam locking system provides heavy-duty security. Available in black or white
- Multiple weather-stripping keeps the elements out
- Available in a range of glass types and thicknesses including double and triple glazing
- Designed to be aesthetically and structurally compatible with other NTI window and door styles
- Standard extrusion colour is solid white. See colour chart for exterior standard and custom colours



### Coil Balance

Premium stainless steel constant force coil balance systems provide smooth and consistent operation.



### Tilt Pin

Sashes either tilt or lift in easily by sliding the contoured tilt pins and releasing the latches.



### Lift Rail

Full sized double-walled lift rail is exceptionally sturdy for years of comfortable and trouble-free operation.

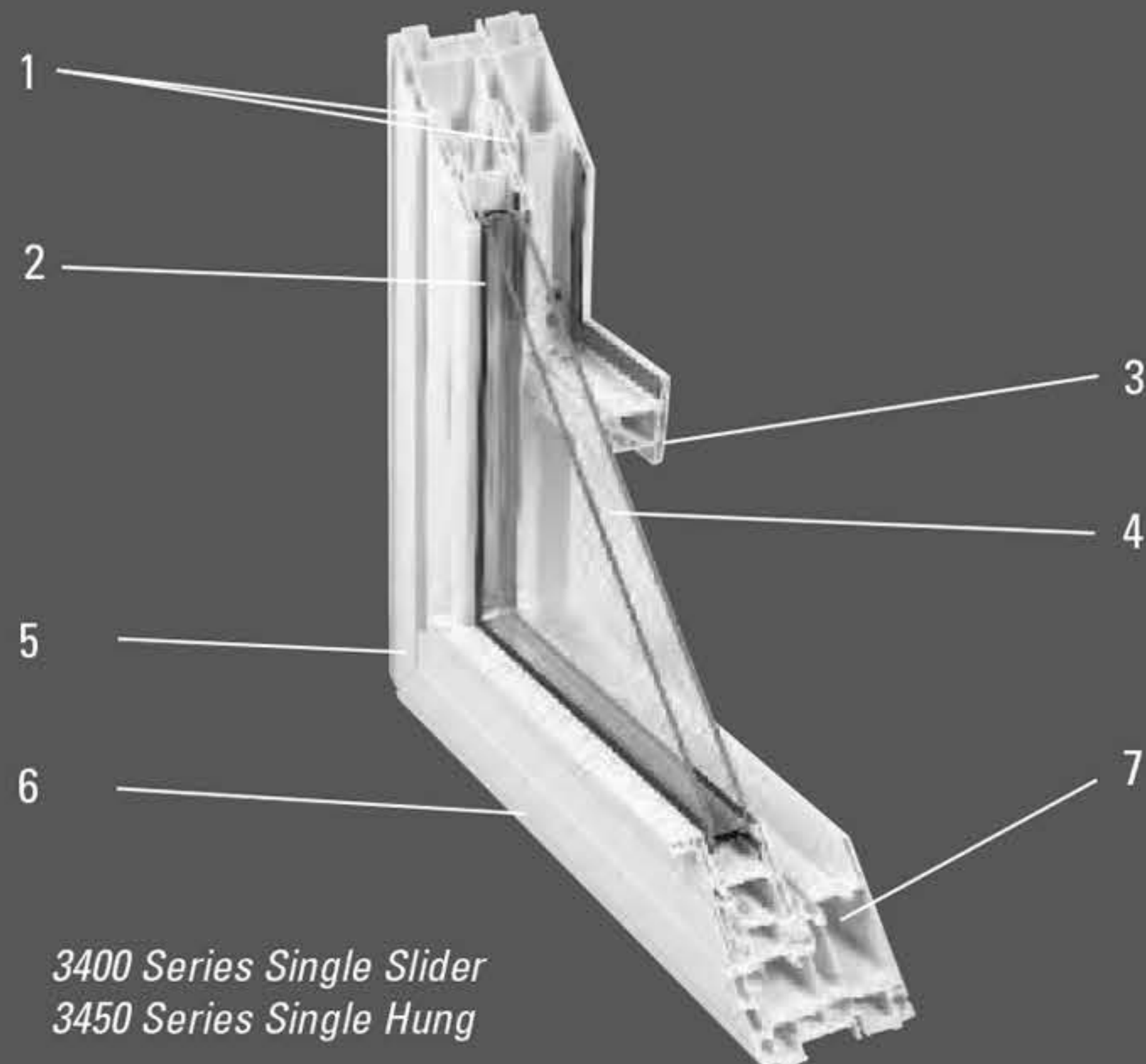

3400 Series Single Slider  
3450 Series Single Hung



4400 Series Single Slider  
4450 Series Single Hung

- Multiple weather-stripping provides remarkable air tightness, reducing heating and air conditioning costs
- Interior glazing bead design allows the window to withstand winds of over 350 km/h (220 mph).
- Easy to operate sash
- Accommodates virtually all types of glazing
- Fusion welded seams create a 100% water and airtight surface and increase the structural integrity of frames and sashes
- Interior and exterior grooves allow for brickmoulds, nailing flanges, returns and jamb extensions
- Strassburger windows have the highest number of internal chambers

### Performance - Test Results

	Air	Water	Wind	Forced Entry
Single Slider	A3/F	B3 - B5	C3 - C5	F20
Single Hung	A3/F	B3 - B4	C3 - C5	F20
Ind. Standard	A1	B1	C1	F1

Products tested to new NAFS standard (AAMA/WDMA/CSA101/I.S.S/A440-08)



# Slider Windows

## Product Description

There are three types of sliding windows available: single, double, and end vent sliders—all functioning as their names suggest. End vent sliders come in a variety of configurations, and all options tilt inwards for easy cleaning.

A traditional looking window that's simple to operate and easy to clean. Single slider windows have one sash fixed while the other opens from side to side. Single hung windows have the top sash fixed in place while the bottom slides up and down and tilts in for easy cleaning. Both window styles offer superior ventilation control, are ideal for the variable Canadian climate and are CSA-A440 compliant and meet EnergyStar® requirements.



- Designed to make life easier, the single hung moveable sash tilts inward for easy cleaning.
- Window operation is smooth, consistent, and effortless
- NTI single slider and single hung windows have outstanding insulation and sound abatement qualities, as well as excellent thermal efficiency and increased strength
- 100% uPVC extrusions are designed to provide superior resistance to severe weather conditions
- Steel cam locking system provides heavy-duty security. Available in black or white
- Multiple weather-stripping keeps the elements out
- Available in a range of glass types and thicknesses including double and triple glazing
- Designed to be aesthetically and structurally compatible with other NTI window and door styles
- Standard extrusion colour is solid white. See colour chart for exterior standard and custom colours



### Coil Balance

Premium stainless steel constant force coil balance systems provide smooth and consistent operation.



### Tilt Pin

Sashes either tilt or lift in easily by sliding the contoured tilt pins and releasing the latches.



### Lift Rail

Full sized double-walled lift rail is exceptionally sturdy for years of comfortable and trouble-free operation.

3400 Series Single Slider  
3450 Series Single Hung

4400 Series Single Slider  
4450 Series Single Hung

- Multiple weather-stripping provides remarkable air tightness, reducing heating and air conditioning costs
- Interior glazing bead design allows the window to withstand winds of over 350 km/h (220 mph).
- Easy to operate sash
- Accommodates virtually all types of glazing
- Fusion welded seams create a 100% water and airtight surface and increase the structural integrity of frames and sashes
- Interior and exterior grooves allow for brickmoulds, nailing flanges, returns and jamb extensions
- Strassburger windows have the highest number of internal chambers

Performance - Test Results				
	Air	Water	Wind	Forced Entry
Single Slider	A3/F	B3 - B5	C3 - C5	F20
Single Hung	A3/F	B3 - B4	C3 - C5	F20
Ind. Standard	A1	B1	C1	F1

Products tested to new NAFS standard (AAMA/WDMA/CSA101/I.S.S/A440-08)



# Tilt and Turn Windows

## Product Description

Our Tilt and Turn windows and doors incorporate advanced technology for exceptional performance. NTI Tilt and Turn designs offer maximum natural light and clear views, with a cohesive, streamlined appearance that complements existing windows and doors beautifully.



Single or combined tilt and turn window

Tilt and turn door

Fully opening French door (hinges on the sides and astragal)

Terrace door with central mullion (option of hinges on the exterior walls or mullions)



Turn the handle upwards and the upper part of the sash tilts slightly to allow for safe and easy ventilation. The opening cannot exceed 4" (130 mm). No danger of intruders or an accident for children, even the rain can't get in.



Simply turn the handle to the horizontal position and the sash pivots vertically to offer a large opening for superior air circulation.



Turn the handle down and the tilt and turn window will be hermetically sealed. No air leakage, maximum security

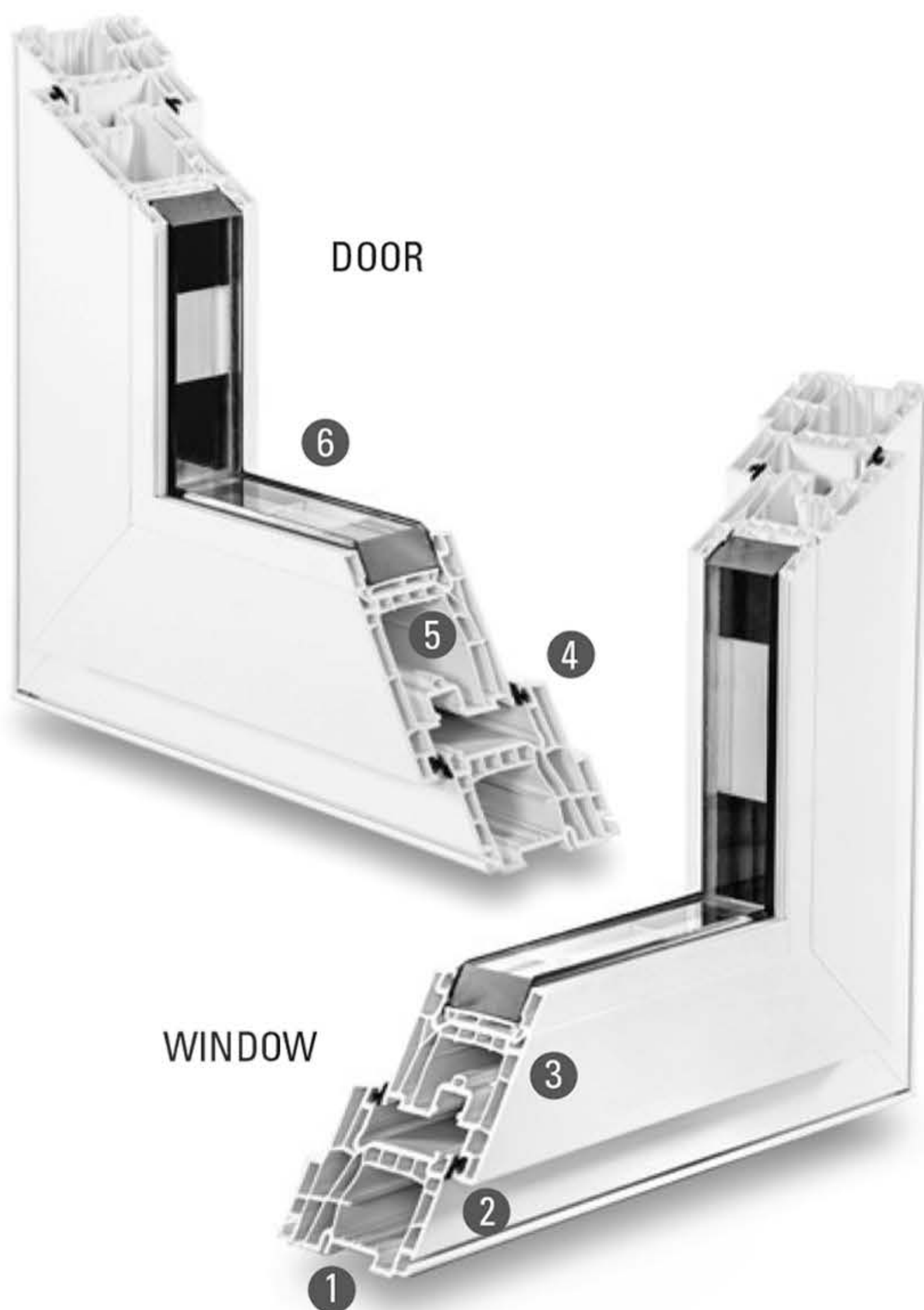

### FEATURES

1. 3 1/4" (82.5 mm) PVC frame
2. Optimized drainage thanks to a pressure balance system and easily positioned drainage cap
3. 2.5 mm exterior walls and interior walls among the thickest on the market for maximum insulation and durability
4. Continuous double weather-stripping with polymer compression seals to eliminate air and water infiltration
5. Multi-chamber structure (17 chambers in the frame, 13 in the sash) to meet the most stringent performance and energy efficiency standards
6. Sashes designed to hold and support glass up to 1 3/4" (44.5 mm) thick
7. Multipoint locking system around the entire perimeter for perfect soundproofing and optimum security and air-tightness

### ADDITIONAL FEATURES

- Door compatible with even the thickest flooring 1.7" (43 mm) clearance
- Optional aluminum sill extension for door configurations
- Spring-loaded screens seamlessly incorporated into windows for sleek architectural styling

### FINISHING DETAILS

Frames are equipped with numerous interior and exterior grooves for a sleek look and no interference with hinges.





# Bay and Bow Windows

## Product Description

### Bay window

A Bay window typically features a large picture window in the center, flanked by two operable casement windows on either side, which can open in the direction of your choice. You can opt for a bay with a seat and head for additional seating or a walkout bay that allows you to walk right up to the window. Both styles enhance natural light in the room and create a unique space to elevate your home's design.

### Bow window

A bow window is made up of four or five adjoining windows that offer beautiful views from multiple angles. Each section can be configured to open in the way that best suits your needs, or remain fixed if preferred.



BAY WINDOW



BOW WINDOW

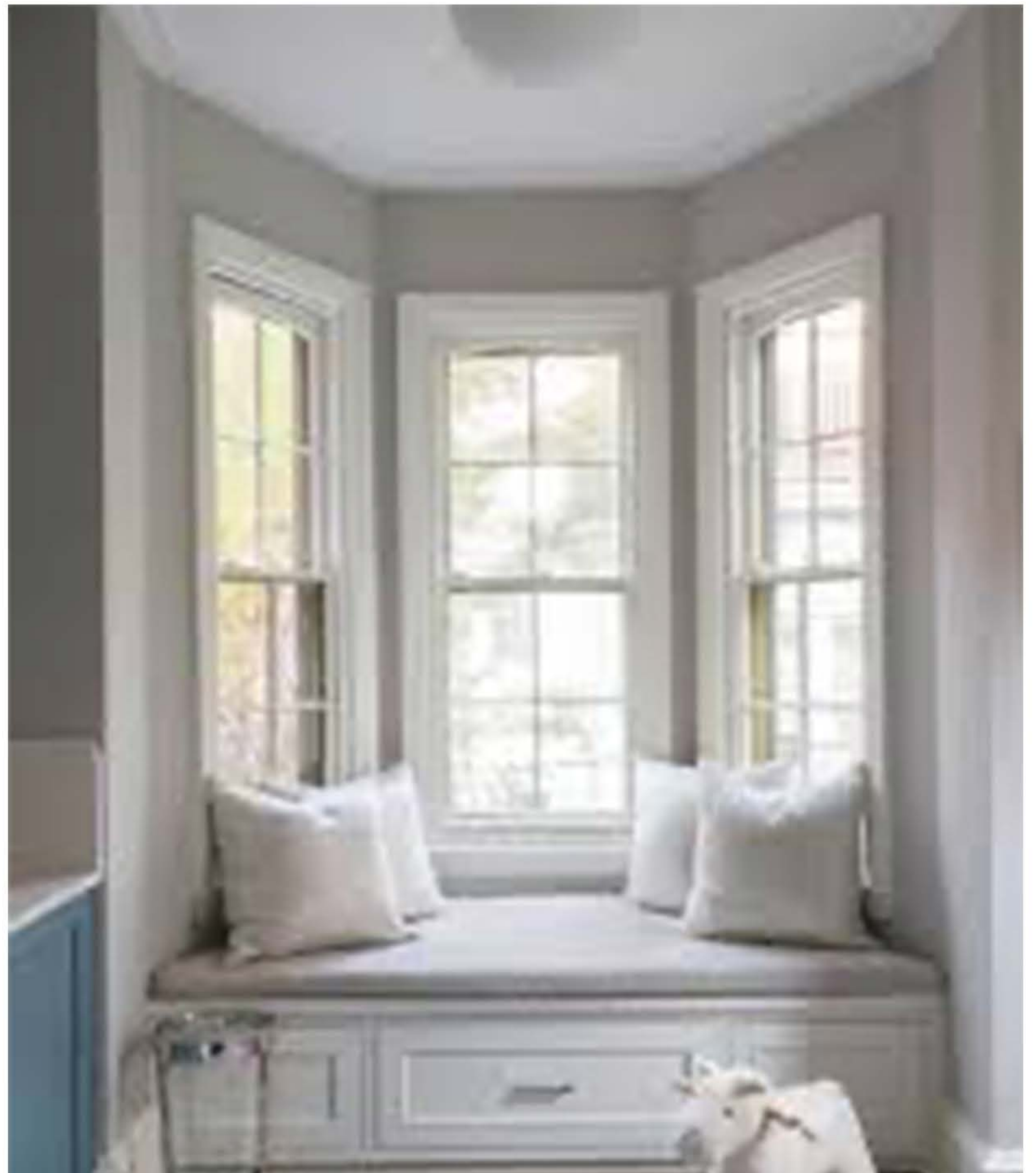



# Door Components

## Description

While many can replicate the look of an entry door system, it's the quality components that make the difference. NTI stays at the forefront of technology to provide some of the most secure and energy-efficient entry doors in the industry, all without compromising on style.



Door and Sidelite Panels

- Made of tough 24 Gauge, hot dipped galvanized steel. Durable and resists rust and corrosion.
- Polyurethane foam filled core, proves stability in the panel, eliminating warping and adds insulation
- Standard lock block on door panels adds reinforcement where the locks are to be installed.
- Standard Steel Panels come in a factory white finish
- Wood perimeter on slabs provides a thermal break between outside & inside surfaces, eliminating condensation and frost



Jambs

- Kiln dried Finger joint pine, prevents warping and cracking
- Available in raw finish as standard but also comes in a paintable PVC laminate which matches the poly-plex finish of the door
- Sizes Available:  
4 5/8 x 1 1/4, 4 5/8 x 1 1/2  
6 1/2 x 1 1/4, 6 1/2 x 1 1/2, 7 1/4 x 1 1/4

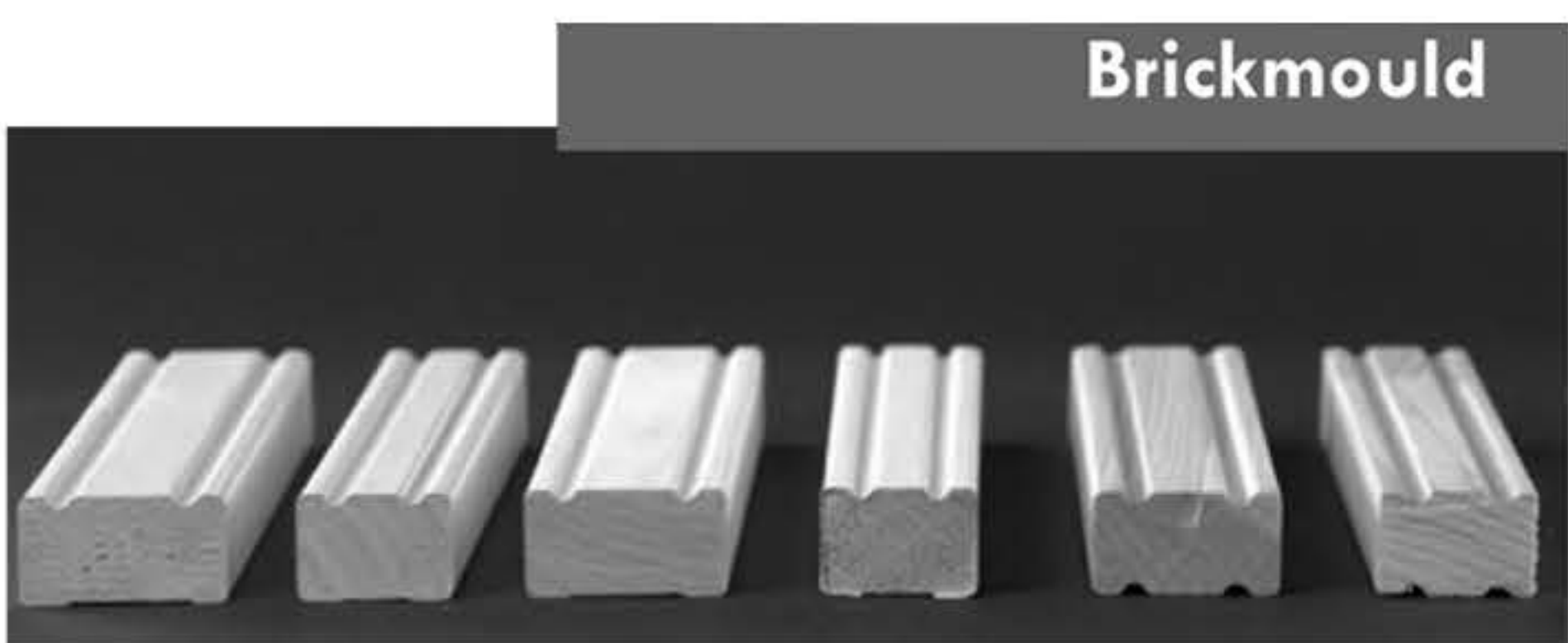

Brickmould

- Has a double bead feature which gives a stylish finishing touch to the exterior of the system.
- Available in 1 5/8" and 2"
- Available in wood, laminated and grain finish which is also paintable to match your entry door system

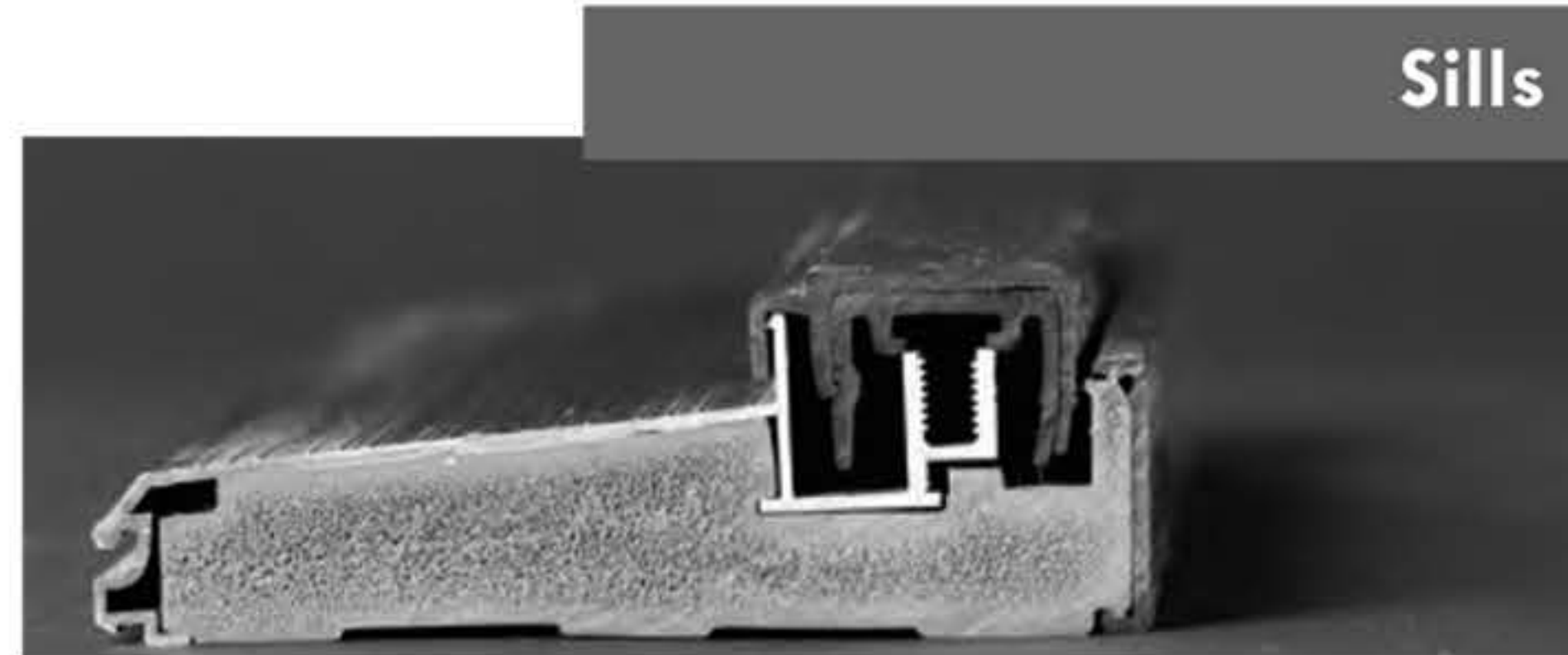

Sills

- Thermally broken to prevent transfer of hot and cold. Stops your door from freezing up.
- Adjustable allowing superior seal
- Also available in black anodize finish
- Available with a variety of extensions 1", 2" and 3"
- Sloped to allow water to move away from the door & home
- Made of a thick aluminum extrusion and has a composite sub-sill giving strength and support to the bottom of the system. The sub-sills will not rot.
- NAFS Certified



Security Plate

- 1/8" steel plates are added at the back of the frame where the lock meets the door adding strength to the frame.
- Aids in the prevention of break-ins.
- 2 additional 1/8" steel plates are added to each Avanti wood frame system at the top and bottom hinge location, adding strength and support.



Hinges

- Ball bearing hinges allows a smooth hinge action and does not squeak when opening and closing door.
- Stops the door from pulling away from the frame after constant use
- Comes in a variety of finishes to match your door hardware or glass coming. Including: brass, black chrome, satin nickel and black matte
- Top and Bottom Hinges of every Avanti door has a Steel plate which strengthens the frame making it difficult for break ins.



Weather Strips

- Fins & bubbles are guaranteed not to tear under normal use
- Screw cover to hide adjustment screws
- Exterior drip cap draws water away from entrance
- Superior Double Bubble seal increases contact with threshold for superior resistance to air and water infiltration.
- Adjustable to ensure a perfect seal between sweep and sill
- Punched Drainage Channel ensures that any water that enters into sweep drains to the exterior of the door.



Glass Frame

- PVC frames with screw cap strips, which cover the installation glass screws, are standard on all Rectangular glass inserts.
- Will not change colour if not painted
- Contoured design adds beauty to the door system
- Coextruded rubber seals prevents water infiltration



Sweeps

- Fins & bubbles are guaranteed not to tear under normal use
- Screw cover to hide adjustment screws
- Exterior drip cap draws water away from entrance
- Superior Double Bubble seal increases contact with threshold for superior resistance to air and water infiltration.
- Adjustable to ensure a perfect seal between sweep and sill
- Punched Drainage Channel ensures that any water that enters into sweep drains to the exterior of the door.



# Door Glass Options



**Alesso**  
V-Groove

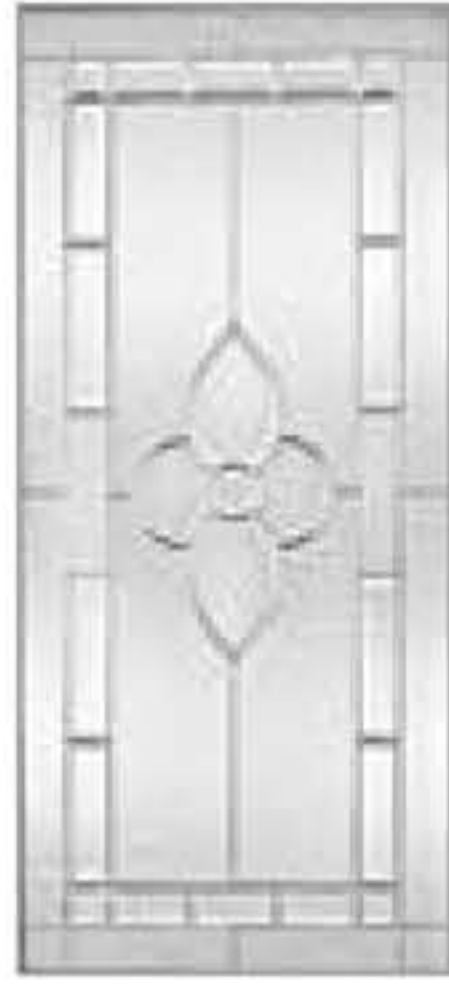

**Allure**  
Stained Glass



**Alys**  
V-Groove



**Attraction**  
Stained Glass



**Avenue**  
Stained Glass



**Azur**  
Silkscreen

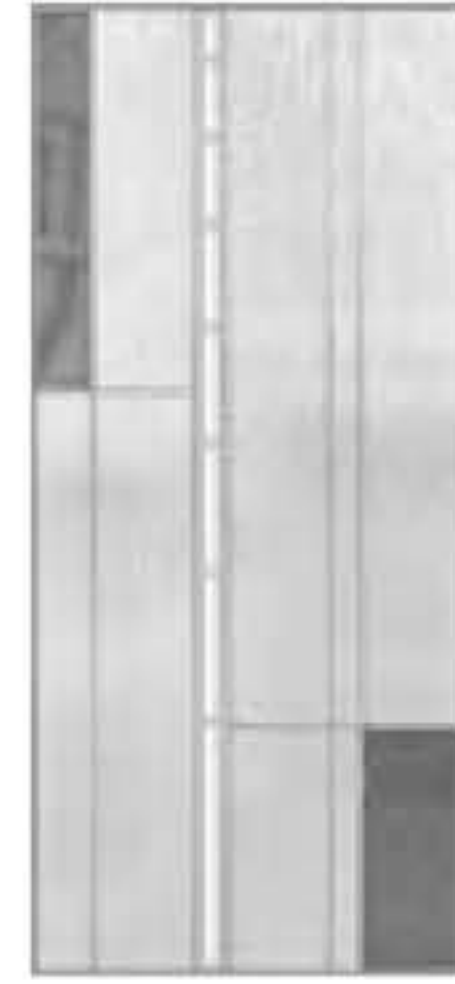

**Barcello**  
Stained Glass



**Beethoven**  
Silkscreen



**Bistro**  
Stained Glass

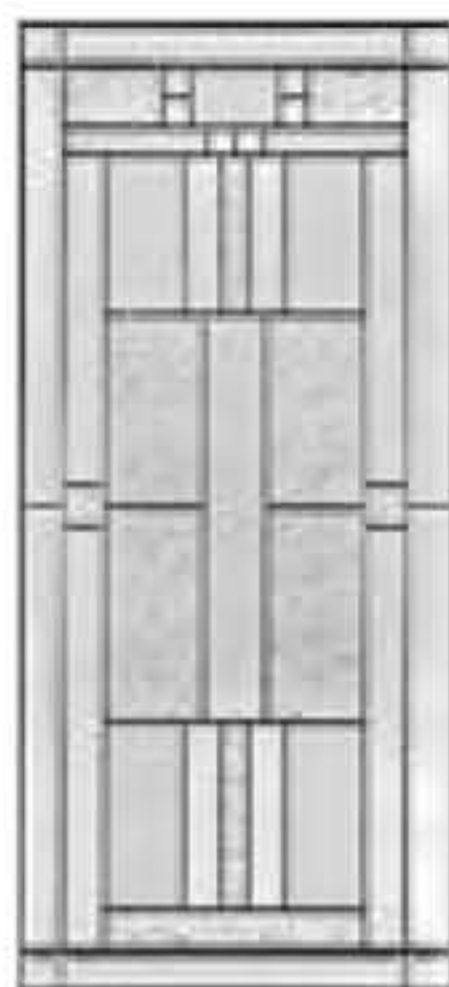

**Cachet**  
Stained Glass



**Cathedral**  
Stained Glass



**Celeste**  
Stained Glass

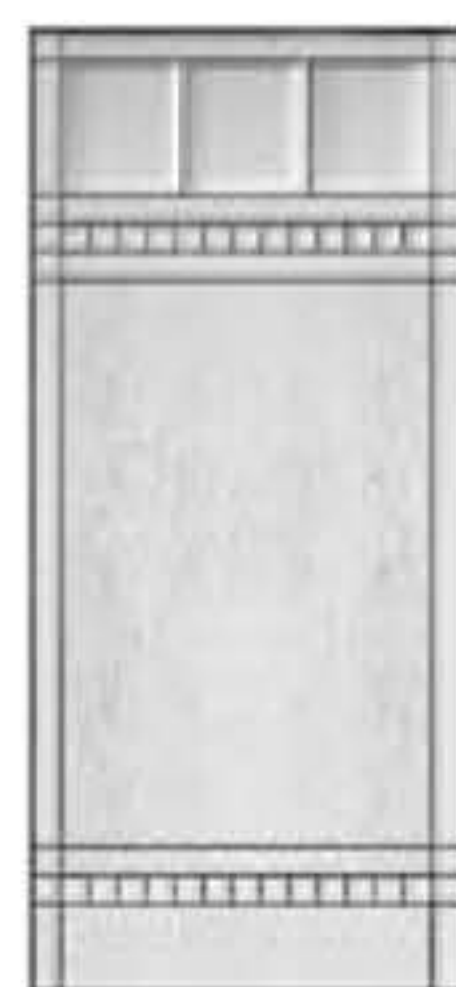

**Chanelle**  
Stained Glass



**Cosmopolitain**  
Stained Glass



**Distinction**  
V-Groove



**Edge**  
Textured Glass



**Evangeline II**  
Stained Glass



**Gothic**  
Stained Glass



**Kallima**  
Stained Glass



**Liano**  
Stained Glass



**Louisbourg**  
Silkscreen

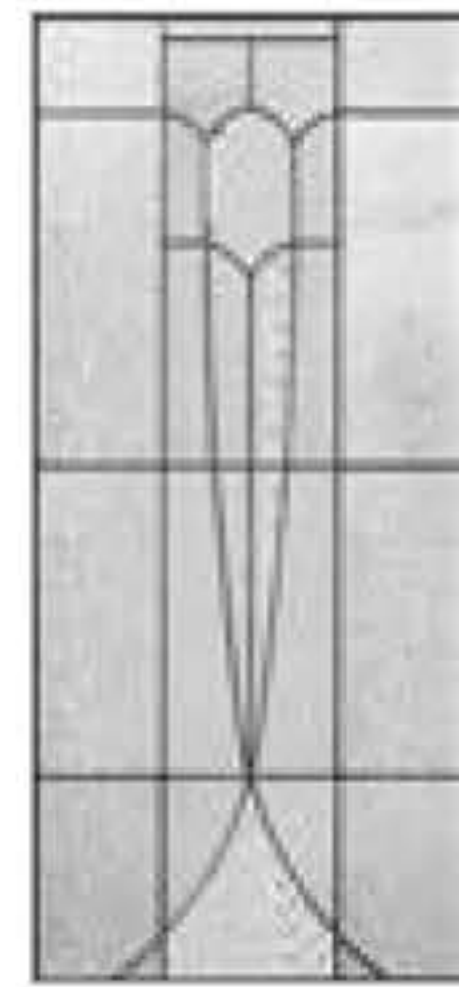

**Mistral**  
Stained Glass



**Mystique**  
Stained Glass



**Nassau**  
Stained Glass



**Opal**  
Stained Glass



**Pure**  
Silkscreen



**Rhythm**  
V-Groove



**St-James**  
Textured Glass



**Tandem**  
Stained Glass



**Transit**  
Silkscreen



**Verso**  
V-Groove



**Zenith**  
V-Groove



# Door Glass Options



BELIZE



CYPRUS



ENZA



FLORENCE



MYKONOS



SANTORINI



BASILICA



OLYMPUS



RAINIER



# Door Glass Options

## Chanelle

Chanelle will bring a stately, elegant and timeless touch to any home, classic or modern. With clean lines and bright bevels, it creates stunning light effects.

**Stained glass:** Chinchilla glass, bevelled clear glass and Niagara glass.

**Caming:** Patina.

**Frames:** Contemporary, Novapvc or Stainable.

**Sidelites and transom:** Looks great accompanied by Niagara glass.

Available in custom sizes.

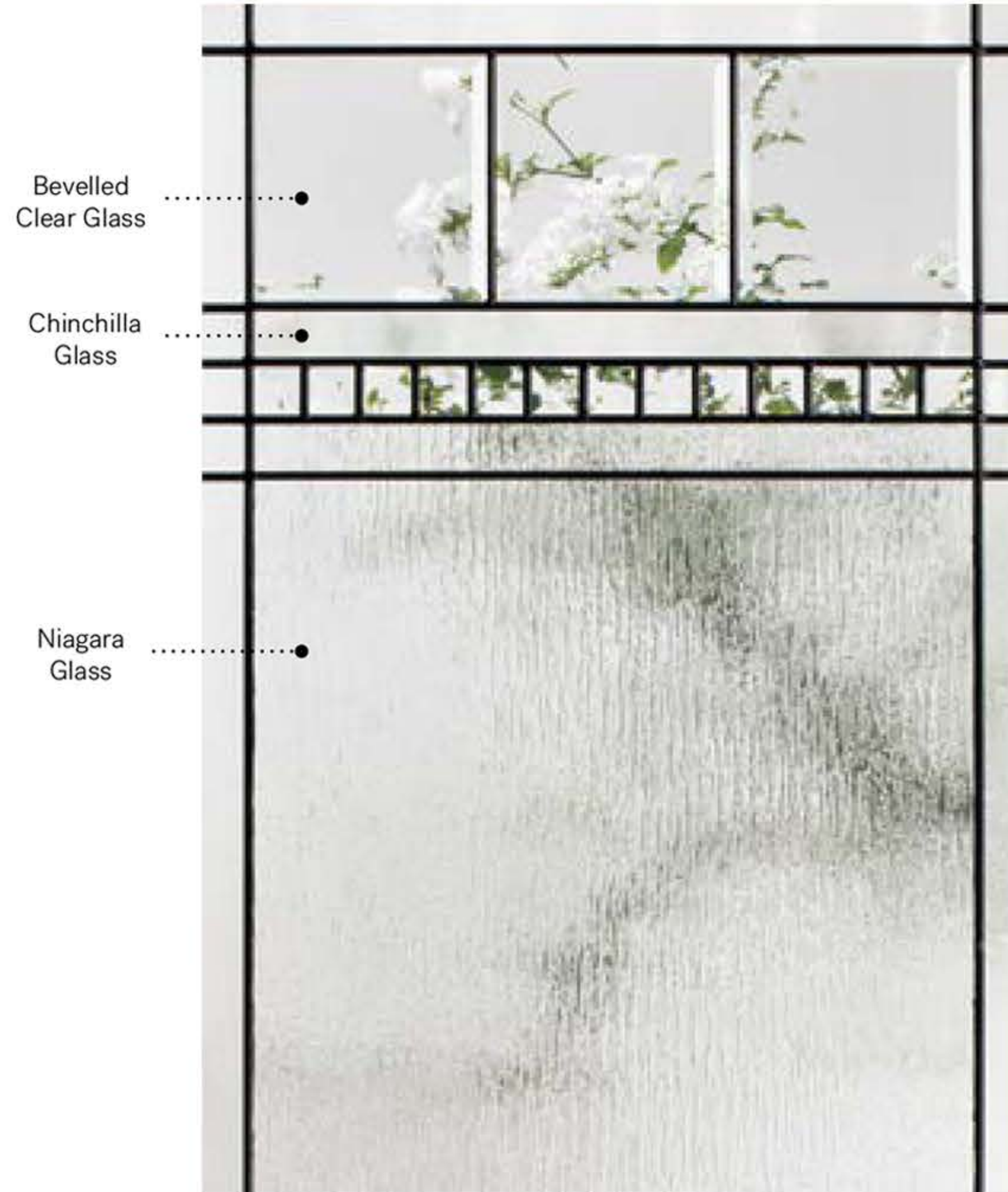

Privacy Level

3/5

SEMI-PRIVATE



Frames	25 1/4" x 65 1/4"	22" x 64"	22" x 48"	22" x 36"	22" x 17"	22" x 14 7/16"
Contemporary	N/D	10-308-060-003	10-308-057-005	N/D	10-308-259-003	10-308-260-001
Novapvc	N/D	10-308-060-001	10-308-057-003	10-308-050-003	10-308-259-001	N/D
Stainable	10-308-359-001	10-308-060-002	10-308-057-004	10-308-050-004	10-308-259-002	N/D



Frames	8" x 48"	8" x 36"	7" x 64" Niagara
Contemporary	10-308-017-003	N/D	08-079-005-200
Novapvc	10-308-017-001	10-308-010-001	08-079-005-201
Stainable	10-308-017-002	10-308-010-002	08-079-005-202



# Door Glass Options

## Pure

Pure adds refinement to your home. An ideal match with black windows and horizontal mullions, Pure is interesting for new construction as well as renovation projects. The subtle clear lines on this silkscreened glass provide a view to the outdoors while ensuring your privacy.

- Silkscreened glass:** Sandblasted ink finish, black ink with clear glass lines.
- Frames:** Contemporary or Novapvc.
- Sidelites and transom:** Looks great accompanied by sandblasted glass.



Black Ink with Clear Glass Lines  
Sandblasted Ink Finish

Privacy Level

3/5

SEMI-PRIVATE



Frames	22"×64" *	20"×64"	22"×48"	7"×64"	8"×48"
Contemporary	07-334-060-003	07-334-038-004	07-334-057-004	07-334-005-004	07-334-017-004
Novapvc	07-334-060-007	07-334-038-005	07-334-057-005	07-334-005-005	07-334-017-005



# Door Glass Options

## Liano

Stylish and warm, Liano is both classic and minimalist. Enjoy a sparkling light effect in your entryway thanks to the bevelled diamonds in its camber top.

**Stained glass:** Chinchilla glass, bevelled clear glass and Diamond glass.

**Caming:** Patina.

**Frames:** Contemporary, Novapvc or Stainable.

**Sidelites and transom:** Looks great accompanied by Chinchilla glass.

Available in custom sizes.

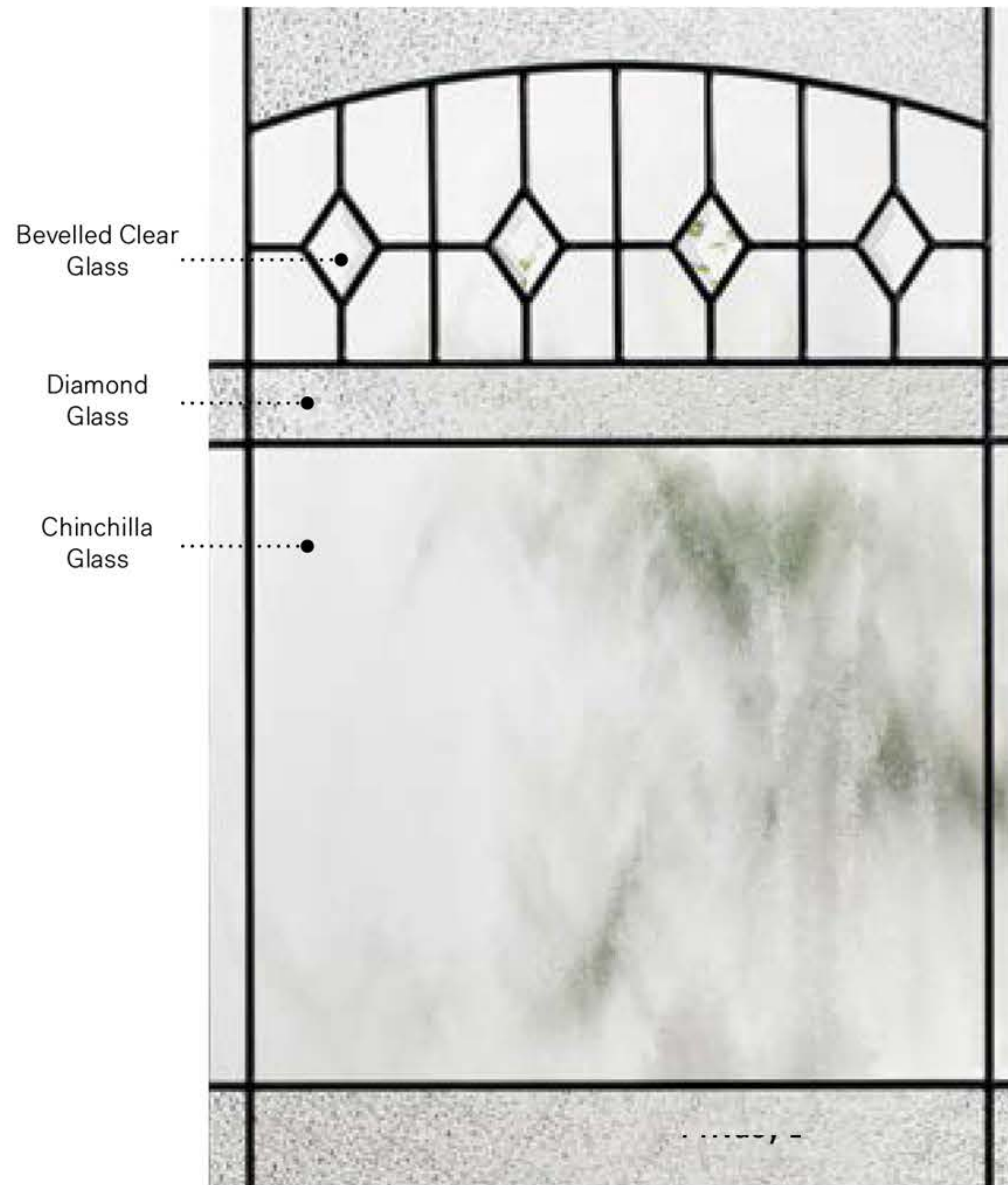

Privacy Level

4/5

PRIVATE



Frames	25 1/4" x 51 1/4"	25 1/4" x 42 1/4"	22" x 48"	22" x 36"	22" x 14 7/16"	21" x 14 3/4"
Contemporary	N/D	N/D	10-324-057-006	10-324-050-009	10-324-260-001	N/D
Novapvc	N/D	N/D	10-324-057-003	10-324-050-001	N/D	10-324-301-002
Stainable	10-324-358-001	10-324-357-001	10-324-057-004	10-324-050-002	N/D	10-324-301-001

Victoria fiberglass door.



Frames	8" x 48"	8" x 36"
Contemporary	10-324-017-006	10-324-010-008
Novapvc	10-324-017-001	10-324-010-001
Stainable	10-324-017-002	10-324-010-002



# Door Glass Options

## Cachet

Cachet's Prairie-style design blends four striking textures to make your home stand out. On sunny days, enjoy a dazzling light effect in your entryway.

**Stained glass:** Bevelled clear glass, Krinkle glass, Chord glass and Pinhead glass.

**Caming:** Zinc or Patina.

**Frames:** Contemporary, Novapvc or Stainable.

**Sidelites and transom:** Looks great accompanied by Pinhead glass.

Available in custom sizes.

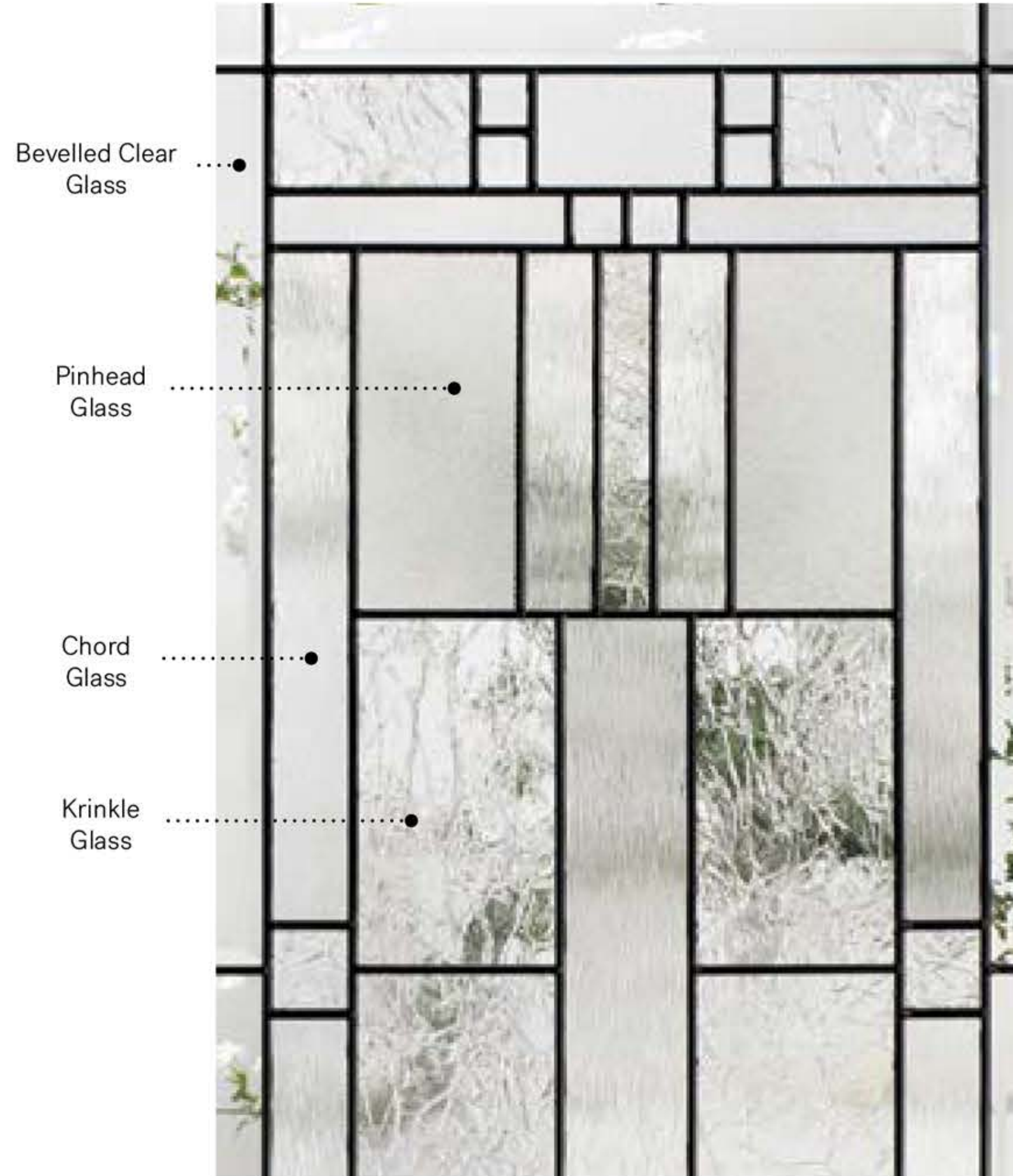

Privacy Level

3/5

SEMI-PRIVATE



Frames	22" x 64"	22" x 48"	22" x 36"	22" x 17"	22" x 14 7/16"	21" x 14 3/4"
	Zinc Pat.	Zinc Pat.	Zinc Pat.	Zinc Pat.	Zinc Pat.	Zinc Pat.
Contemporary	10-230-060-013 014	10-230-057-024 025	10-230-050-024 025	10-230-259-010 011	10-230-260-010 011	N/D
Novapvc	10-230-060-002 001	10-230-057-003 001	10-230-050-003 001	10-230-259-002 001	10-230-260-001 002	10-230-301-003 001
Stainable	10-230-060-005 011	10-230-057-005 006	10-230-050-005 006	10-230-259-007 006	N/D	10-230-301-006 005

Victoria fiberglass door.



Frames	22" x 9" Camber	21 5/8" x 9 3/4" Half-moon	7" x 64"	8" x 48"	8" x 36"	13 7/8" x 79" Tip-to-tip
	Zinc Pat.	Zinc Pat.	Zinc Pat.	Zinc Pat.	Zinc Pat.	Zinc Pat.
Contemporary	N/D	N/D	10-230-005-013 014	10-230-017-018 019	10-230-010-020 021	10-230-211-002 001
Novapvc	10-230-251-001 002	10-230-044-010 009	10-230-005-002 001	10-230-017-003 001	10-230-010-003 001	
Stainable	10-230-251-003 004	10-230-044-008 007	10-230-005-011 010	10-230-017-005 006	10-230-010-005 006	



# Door Glass Options

## Allure

With its assertive jewelled central floral element, Allure never fails to impress.

**Stained Glass:** Bevelled clear glass and Glue Chip glass.

**Caming:** Zinc or Brass.

**Frames:** Novapvc or Stainable.

**Sidelites and transom:** Looks great accompanied by Glue Chip glass.

Available in custom sizes.

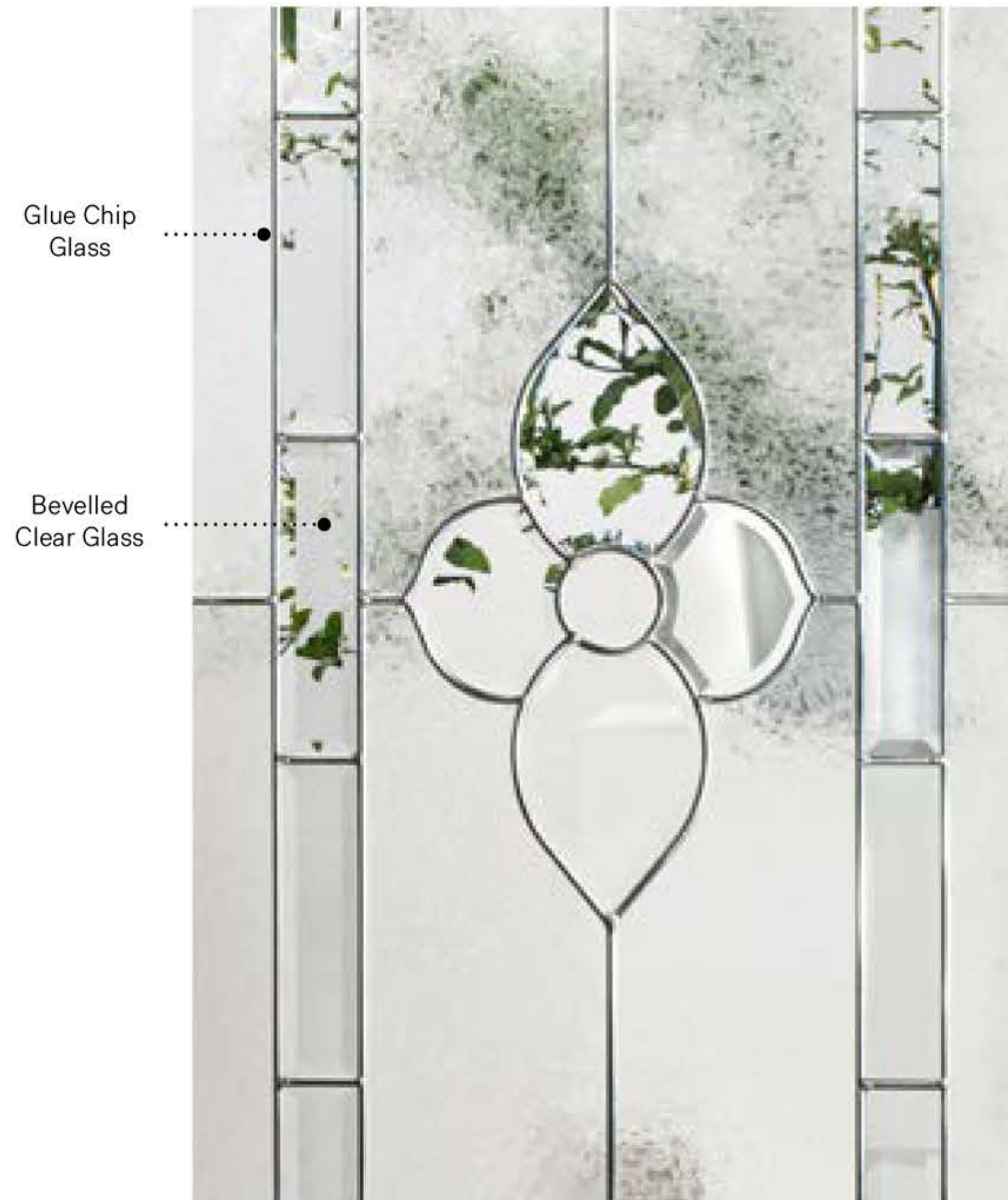

Privacy Level

2/5

SEMI-PRIVATE



Frames	22" x 48"		22" x 36"		15 25/32" x 39 25/32" Oval		
	Zinc	Brass	Zinc	Brass	Zinc	Brass	
Novapvc	10-002-057	004	002	10-002-050	009	003	N/D
Stainable	10-002-057	011	010	10-002-050	016	008	10-002-027



Frames	7" x 64"		8" x 48"		8" x 36"		
	Zinc	Brass	Zinc	Brass	Zinc	Brass	
Novapvc	10-002-005	002	001	10-002-017	003	001	10-002-010
Stainable	10-002-005	018	017	10-002-017	015	014	10-002-010



# Door Glass Options

## Alys

Alys' V-Groove design suggests motion and is at once natural and abstract, bringing your entryway to life with its dynamic composition.

**V-Groove:** Polished V-Groove lines on sandblasted glass.

**Frames:** Contemporary, Novapvc or Stainable.

**Sidelites and transom:** Looks great accompanied by sandblasted glass.

Available in custom sizes.

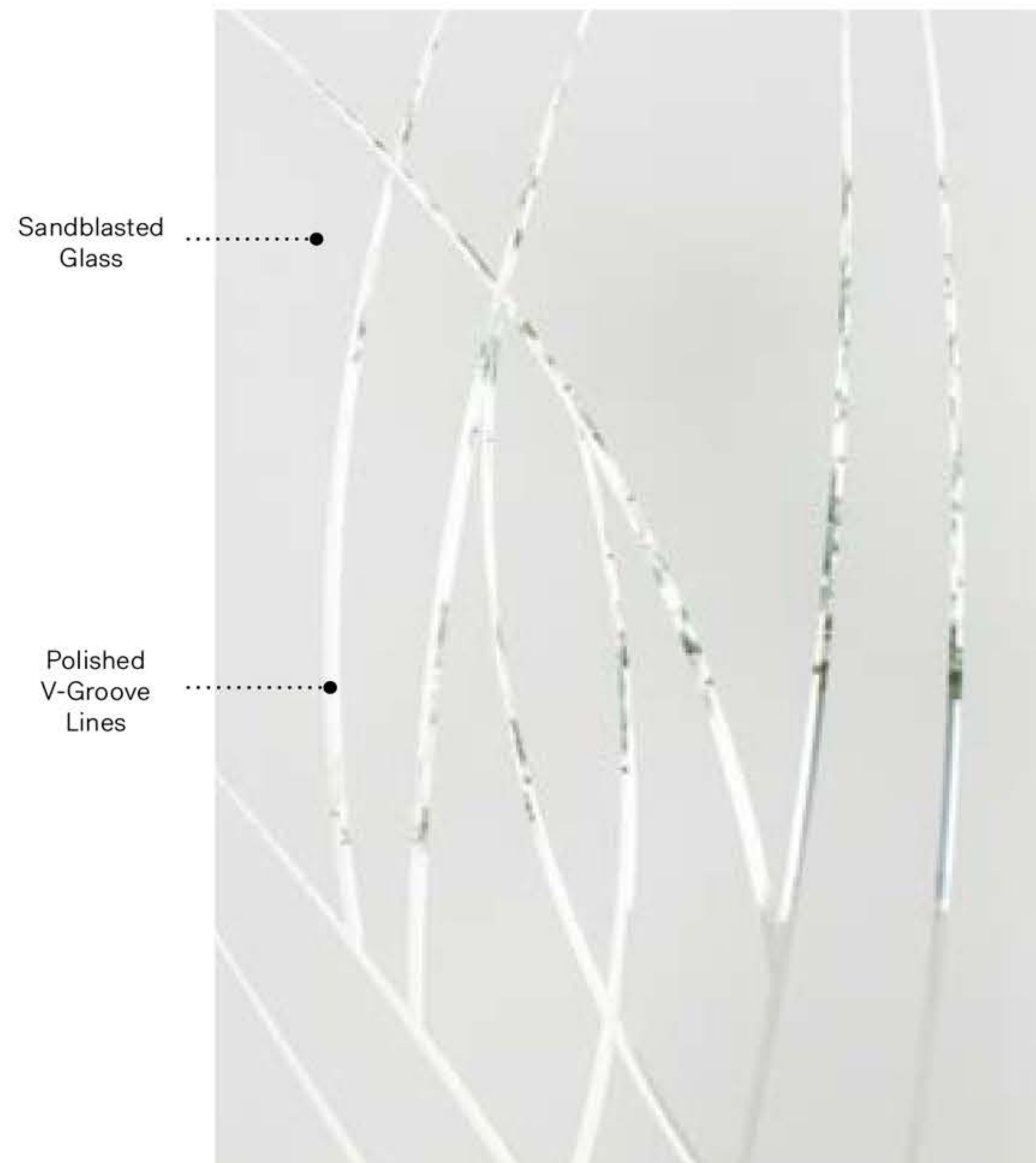

Sandblasted Glass

Polished V-Groove Lines

Privacy Level

4/5

PRIVATE



Frames	22" x 64"	22" x 48"	22" x 36"	22" x 17"	22" x 14 7/16"	21" x 14 3/4"	22" x 9"
Contemporary	06-322-060-007	06-322-057-009	06-322-050-011	06-322-259-007	06-322-260-006	N/D	06-322-210-006
Novapvc	06-322-060-001	06-322-057-001	06-322-050-001	06-322-259-001	06-322-260-001	06-322-301-001	06-322-210-001
Stainable	06-322-060-003	06-322-057-003	06-322-050-003	06-322-259-002	N/D	06-322-301-003	06-322-210-003

Victoria fiberglass door.



Frames	22" x 9" Camber	7" x 64"	8" x 48"	8" x 36"	13 7/8" x 79" Tip-to-tip
Contemporary	N/D	06-322-005-008	06-322-017-009	06-322-010-009	06-322-211-001
Novapvc	06-322-251-001	06-322-005-001	06-322-017-001	06-322-010-001	
Stainable	06-322-251-003	06-322-005-003	06-322-017-003	06-322-010-003	



# Door Components

## Internal Mini Blinds

A single operating system allows ease of opening and closing built in blinds. Internal blinds prevent dust from accumulating. Blinds adjust for complete light block, and the privacy channels on each side eliminate light gaps. When the blinds are closed - no street light shadows or sunlight glare. You will have more privacy at night and increased sense of security.

- Efficient Force to lift ratio for easy operation
- Reliability tested lines
- Robust internal mechanisms assure durability
- UV coated & Energy efficient insulated glass
- Control of light and privacy
- Safe for children and pets
- No dusting



### AVAILABLE SIZES

20 x 64	22 x 36	8 x 36
22 x 64	22 x 48	8 x 64
	22 x 80	8 x 80

## Vent

The Elevation venting windows allows for smooth operation. Its weight balancing system offers minimal effort for better and safer control.

- Glass Options:
- + Low E Argon Clear Glass (shown)
- + Masterline Glass (Horizontal)
- + Optika Silkscreened Glass
- + Internal Flat White Grill



22 x 64' 20 x 64'	22 x 64' 20 x 64'	22 x 64' 20 x 64'	22 x 64' 20 x 64'	22 x 64' 20 x 64'
22 x 48'	22 x 48'	22 x 48'	22 x 48'	22 x 48'
22 x 36'	22 x 36'	22 x 36'	22 x 36'	22 x 48'
Clear Glass	Distinction Grill	Optika Silkscreen	Perimeter Grill	Transit Silkscreen



# Door Glass **Frames**

## Standard Frame

- All our rectangular glass insert comes with PVC frame
- Strip Screw Cover provides a seamless interior finish
- Co-extruded PVC gasket eliminates the need for messy caulking.
- Does not yellow over time
- Does not need to be painted



Exterior View



Interior View

## Flat Urban PVC Frame

- sleek new design with clean modern lines
- provide optimal performance
- co-extruded tri-glaze for maximum seal & insulation
- note: size limitation apply



New Urban Interior View



New Urban PVC Exterior View



New Urban ExteriorView

## Flat Urban PVC Frame

- Nothing on the market equals this Frame
- Offered in two finishes: white or anodized. Can also be painted to match door colour
- This modern look is the latest in glass frame
- Maximum performance (Aesthetic cover strip inside hides screws.)
- Highly recommended with use of storm doors and dark painted colour
- Will not warp
- note: size limitation apply



New Urban PVC Interior View



New Urban Aluminum  
Exterior View



# Executive Panels



EXE092/094/092



EXE104/098



EXE 090 (3)



EXE 094/102/094



EXE 108



RA2248  
EXE098

custom sizes available



# Steel Slabs



**MUNDO**

34 X 79  
36 X 79



**OSO**

34 X 79  
36 X 79



**SOHO**

32 X 79  
34 X 79  
36 X 79



**ERA**

32 X 79  
34 X 79  
36 X 79



**TAO**

34 X 79  
36 X 79

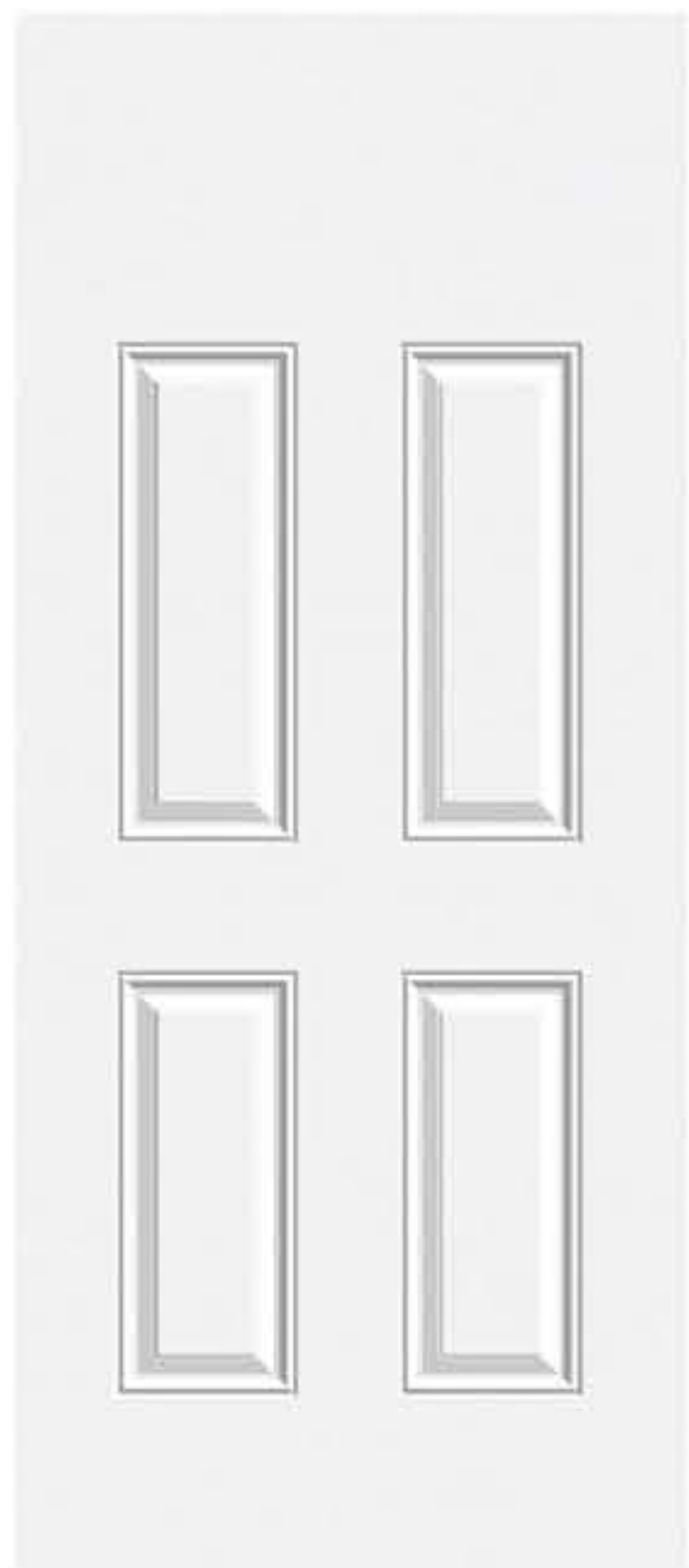

**4P**

32 X 79  
34 X 79  
36 X 79



**VOG**

34 X 79  
36 X 79

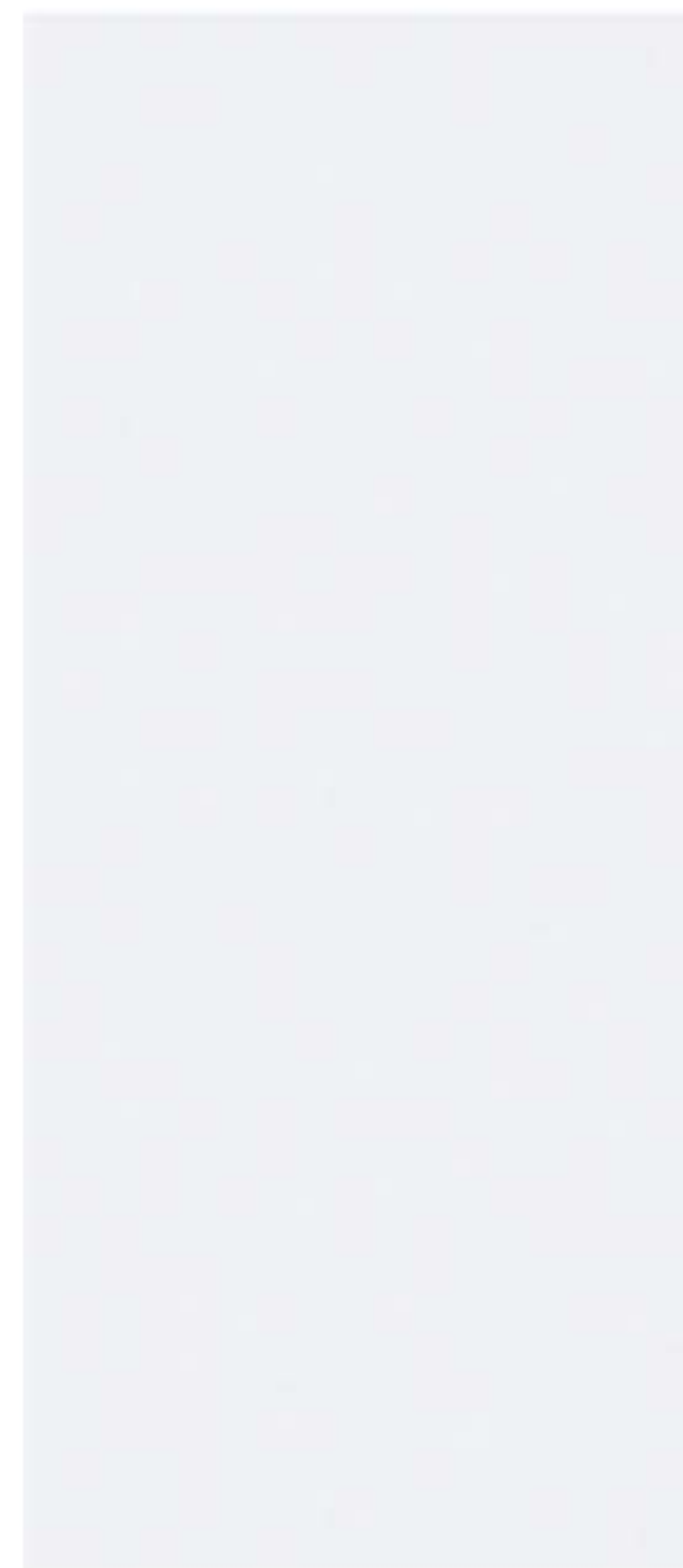

**FL**

30 X 79    32 X 95  
32 X 79    34 X 95  
34 X 79    36 X 95  
36 X 79



**LINEA**

32 X 79  
34 X 79  
36 X 79



**LON**

32 X 79  
34 X 79  
36 X 79



# Steel Slabs

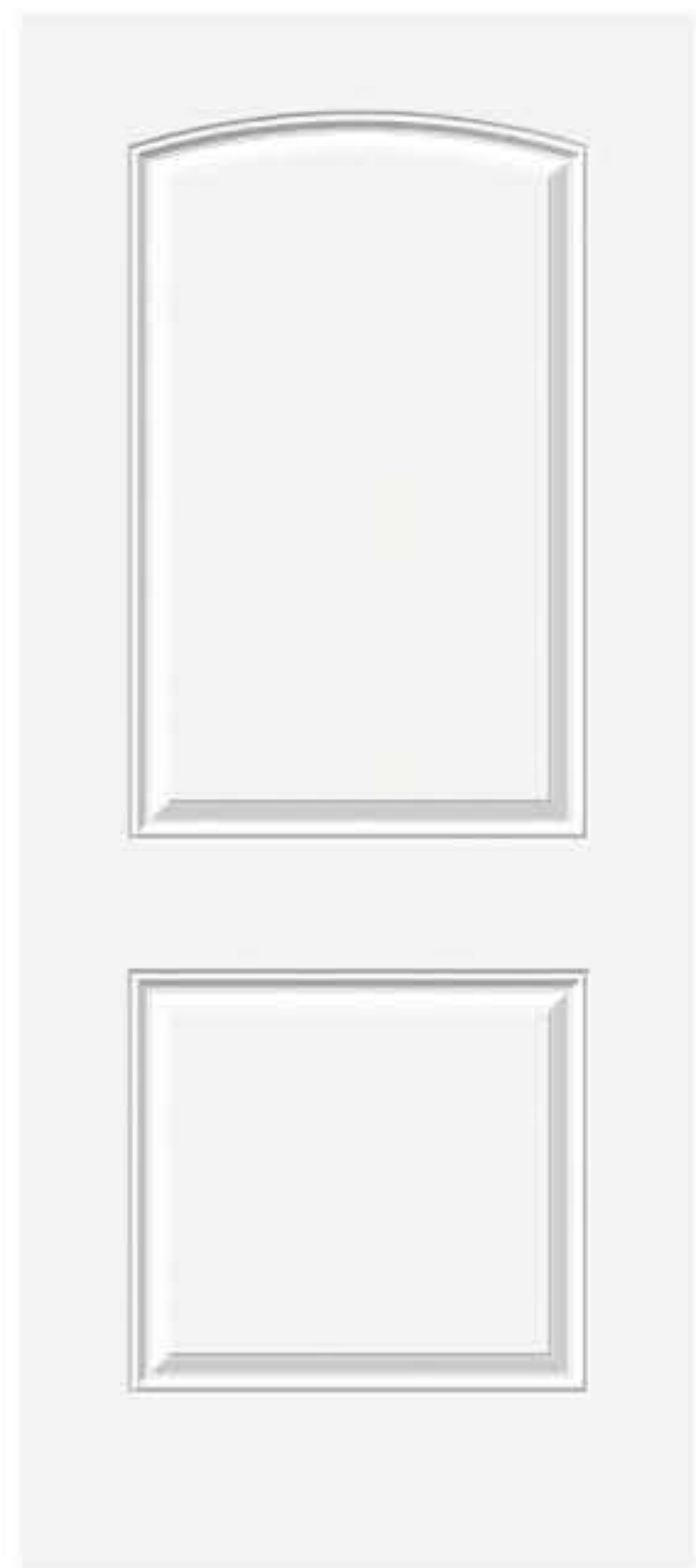

**2PCT**

32 X 79  
34 X 79  
36 X 79



**3P**

32 X 79  
34 X 79  
36 X 79



**SYD**

32 X 79  
34 X 79  
36 X 79



**2P0**

32 X 79 32 X 95\*  
34 X 79 34 X 95\*  
36 X 79 36 X 95\*



**2PPCT**

32 X 79  
34 X 79  
36 X 79

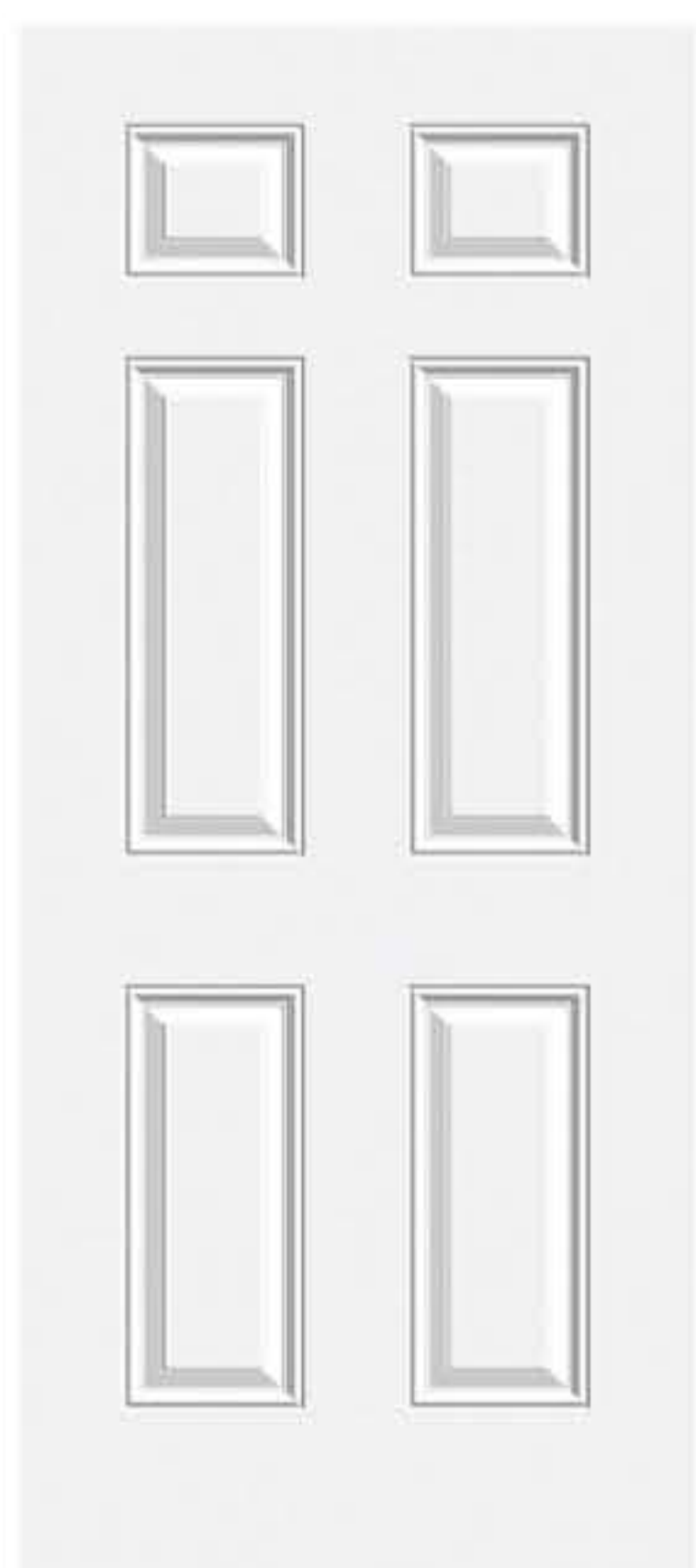

**6P**

30 X 79  
32 X 79  
34 X 79  
36 X 79



**VIC**

32 X 79  
34 X 79  
36 X 79



**SFL**

14 X 79  
14 X 95



**REV**

14 X 79



**S3P**

14 X 79

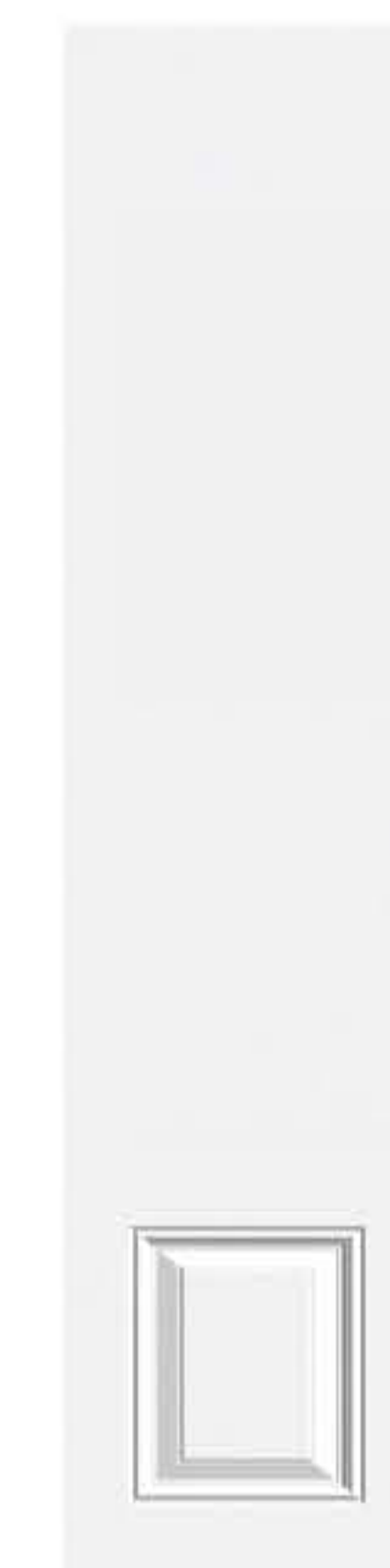

**SOR**

14 X 95

*\*note: size must have 2264 glass*



# Smooth Fiberglass **Slabs**



SM-4P  
32 X 79  
34 X 79  
36 X 79

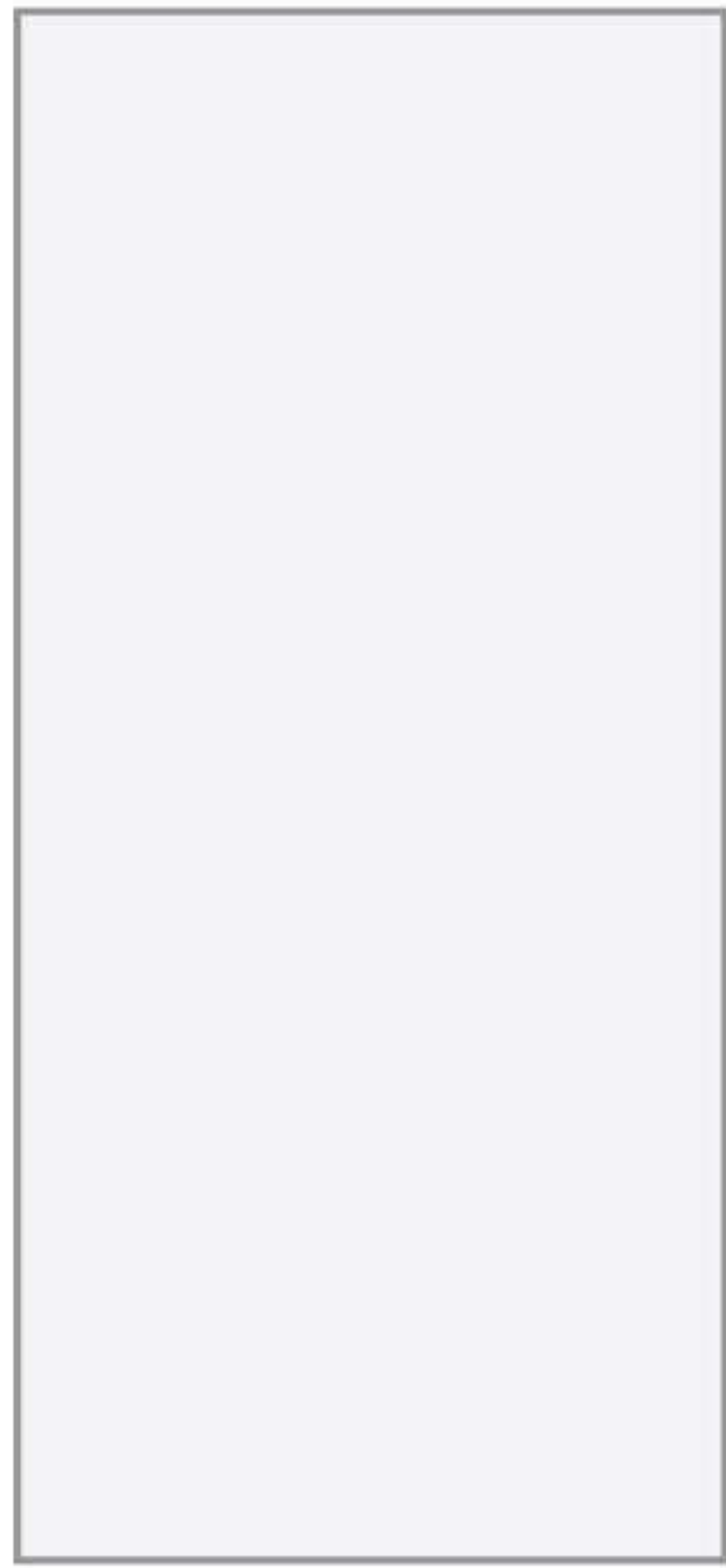

SM-FL  
30 X 79  
32 X 79  
34 X 79  
36 X 79  
42 X 79



SM-2P0  
32 X 79  
34 X 79  
36 X 79



SM-VIC  
32 X 79  
34 X 79  
36 X 79



SM-L0N  
32 X 79  
34 X 79  
36 X 79



SM-6P  
32 X 79  
34 X 79  
36 X 79



SM-2PPCT  
32 X 79  
34 X 79  
36 X 79



SM-R IC  
32 X 79  
34 X 79



SMFLSL  
4 X 79  
4 X 95  
8 X 79



SM-REV  
14 X 79



# Fiberglass **Slabs**



MAH-2P  
Santorini



MAH-2P  
Belize



MAH-2P  
Cyprus



MAH-2P  
Enza



MAH-2P  
Florence



WG-6P  
Mykonos



WG-6P  
Olympus



WG-6P  
Rainier



WG-6P  
Basilica



# Mahogany Grain Fiberglass Slabs



MAH-CRF  
36 X 79



MAH-2P0  
32 X 79 32 X 95  
34 X 79 34 X 95  
36 X 79 36 X 95



MAH-3P  
32 X 79  
34 X 79  
36 X 79



MAH-2PPCT  
32 X 79 32 X 95  
34 X 79 34 X 95  
36 X 79 36 X 95  
42 X 95



MAH-C3P  
32 X 79  
34 X 79  
36 X 79



MAH-FL  
32 X 79 36 X 95  
34 X 79  
36 X 79



MAH-GP  
32 X 95 36 X 95  
34 X 95 42 X 95



MAH-GR6  
32 X 79  
34 X 79  
36 X 79



MAH-GR5  
32 X 79  
34 X 79  
36 X 79



MAH-GR4  
32 X 79  
34 X 79  
36 X 79



MAH-GR3  
32 X 79  
34 X 79  
36 X 79



MAH-GR2  
32 X 79  
34 X 79  
36 X 79



MAH-GR1  
32 X 79  
34 X 79  
36 X 79



MAH-SFL  
14 X 79  
14 X 95



MAH-2PSL  
14 X 79



# Oak Grain Fiberglass **Slabs**



**WG-FL**

30 X 79  
32 X 79  
34 X 79  
36 X 79

32 X 95  
34 X 95  
36 X 95



**WG-2PO**

32 X 79  
34 X 79  
36 X 79

32 X 95  
34 X 95  
36 X 95



**WG-LON**

32 X 95  
34 X 95  
36 X 95



**WG-3P**

32 X 79  
34 X 79  
36 X 79



**WG-4P**

32 X 79  
34 X 79  
36 X 79



**WG-6P**

32 X 79  
34 X 79  
36 X 79

32 X 95  
34 X 95  
36 X 95



**WG-8P**

34 X 79  
36 X 79



**WG-CTP**

32 X 79  
34 X 79  
36 X 79



**WG-C3P**

32 X 79  
34 X 79  
36 X 79



**WG-1P**

32 X 79  
34 X 79  
36 X 79



**WG-SFL**

14 X 79  
14 X 95



**WG-REV**

14 X 79  
14 X 95



# Door Hardware

## Multipoint Locks

### Product Features:

- Provide security against forced entry
- Help prevent air infiltration
- Protect the door panel from warping
- 3 Point, one piece locking system for 6' 8' and 8' Doors
- Heavy duty mortise construction with reinforced lever
- 90-degree turn of key or thumb-turn
- No lifting of handle to engage locking points
- Top and bottom automatic latch bolts



 <p><b>GML 100C</b> Available Finishes</p> <p>US5 - Antique Brass US15 - Satin Nickel US15A - Pewter US10B - Oil Rubbed Bronze US19 - Flat Black Plate Size: 3" x 19 3/4"</p>	 <p><b>GML 400C - 910</b> Available Finishes</p> <p>US15A - Pewter US10B - Oil Rubbed Bronze US19 - Flat Black US14 - Polished Nickel US15 - Satin Nickel Plate Size: 3 3/8" x 17 3/4"</p>	 <p><b>GML 300C</b> Available Finishes</p> <p>US5 - Antique Brass US15 - Satin Nickel US15A - Pewter US10B - Oil Rubbed Bronze US19 - Flat Black Plate Size: 3 1/8" x 18 1/2"</p>	 <p><b>VENICE</b> Available Finishes</p> <p>Polished Chrome Polished Brass Satin Chrome Satin Nickel Antique Brass Pewter Dark Bronze Oil Rubbed Bronze Plate Size: 1 3/4" x 9"</p>	 <p><b>CAPRI</b> Available Finishes</p> <p>Polished Chrome Polished Brass Satin Chrome Satin Nickel Antique Brass Pewter Dark Bronze Oil Rubbed Bronze Plate Size: 1 3/4" x 9"</p>	 <p><b>TORINO</b> Available Finishes</p> <p>Polished Brass Satin Chrome Satin Nickel Antique Brass Pewter Dark Bronze Oil Rubbed Bronze Plate Size: 1 3/4" x 9"</p>	 <p><b>ROMA</b> Available Finishes</p> <p>Satin Nickel Pewter Dark Bronze Plate Size: 2 1/8" x 12 1/4"</p>
---	---	--	---	---	--	---



# Patio Doors

## Product Description

Thanks to the sturdy, patented dual-tandem wheels, NTI Patio doors always slide smoothly and quietly. Tested to endure 119,000 cycles with a 165 lb. sash—equivalent to over 30 years of continuous use—they've proven their durability without a single failure. Plus, the wheels now feature sealed bearings for extended lifespan.

Give the fingertip test a try—you can open this door with just the tip of your finger! It's the easiest door to operate in its class.

- Our lock features retractable latches that won't break if closed improperly.
- The monorail design uses sturdy, all-aluminum, angle legged tracks for added stability and effortless operation.
- Smooth sliding is guaranteed with screen doors, thanks to patented, spring-loaded rollers that are fully adjustable at each corner, preventing any derailing.
- With an installer-friendly design, NTI doors make plumb and square alignment simple, even on uneven surfaces.



White



Black



Oil Rubbed Bronze



Brushed Antique Chrome



Brushed Nickel



Coppertone





# Tilt & Turn Patio Doors

## Product Description

European-inspired yet crafted for North America, our versatile, high-performance TNT doors are available in a variety of sizes and styles, with customizable finishes, accessories, and energy-efficient options. Add a fresh twist to your next residential or commercial project with NTI.



Tilt and turn door



Fully opening French door  
(hinges on the sides and astragal)



Terrace door with central mullion  
(option of hinges on the exterior walls or mullions)





# Multi Track Patio Doors

## Product Description

The NTI Multi-Track Patio Door system features an all-PVC frame with a mechanically constructed sash, designed for spacious openings, enhanced safety, and added convenience.

Its unique double roller track allows panels to slide and stack neatly within the frame, minimizing floor space use. Effortless to open and close, every detail has been carefully crafted to ensure a smooth glide for a door of this size.

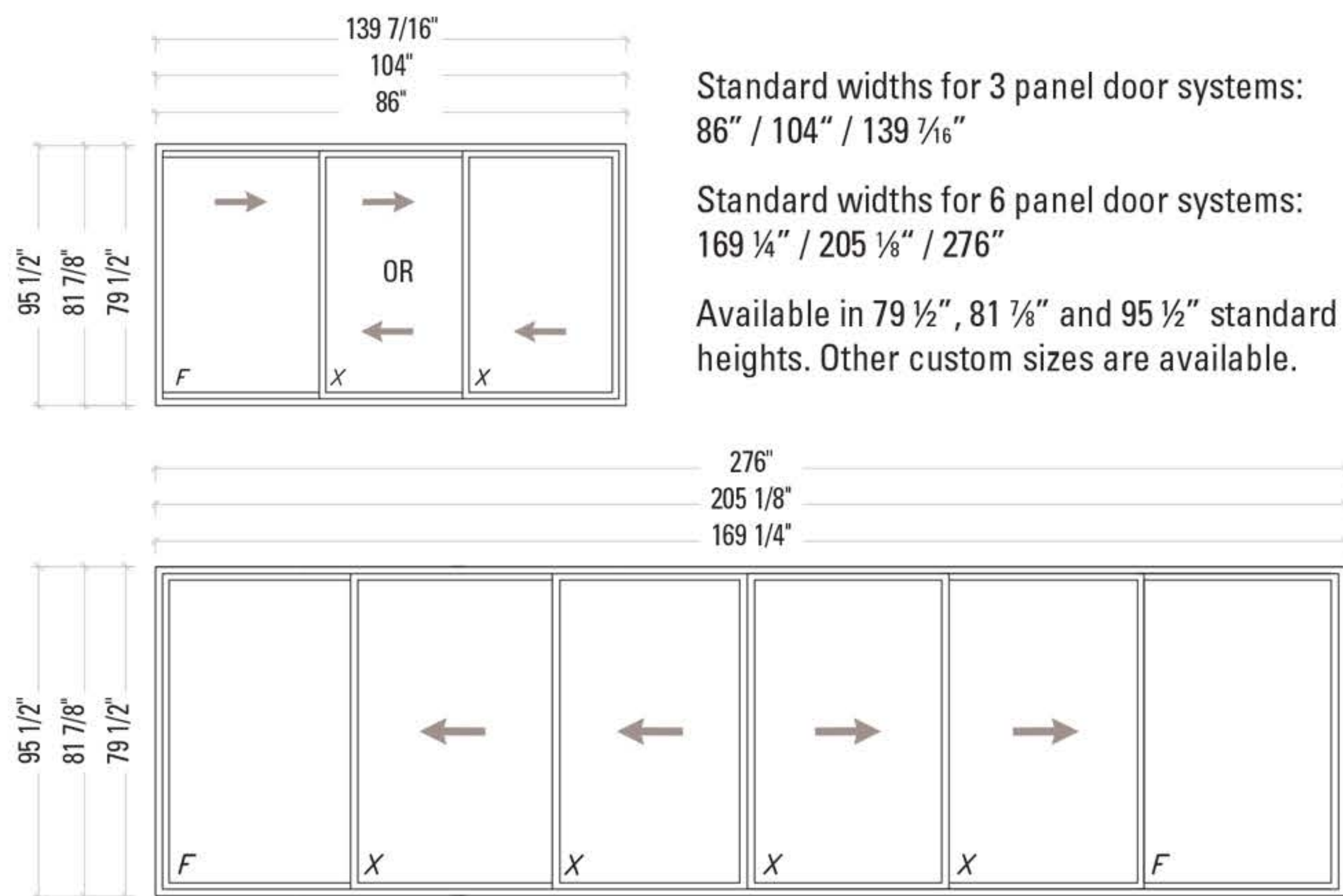

Contemporary  
- Black



Contemporary  
- Satin Nickel



Contemporary  
- White



Modern  
- Black



Modern  
- Satin Nickel



Modern  
- White



Sleek  
- Satin Nickel

Modern and Sleek hardware is not recommended for 3-panel configurations with screens.





# Garage Doors

## Product Description

NTI Garage Doors reach a R-Value of 16 , this reduces heat flow and improves energy efficiency by 5% compared to that of an R-8 Door.

- 24 gauge galvanized steel with 2 coats of prefinished paint to ensure longevity
- 2" thickness sandwich panel with polyurethane foam injection in between of two steels provides superior strength.
- R-16 Removes street noise and increases garage's thermal efficiency.
- The tongue and groove meeting rails of each panel sections for better sealing against exterior materials

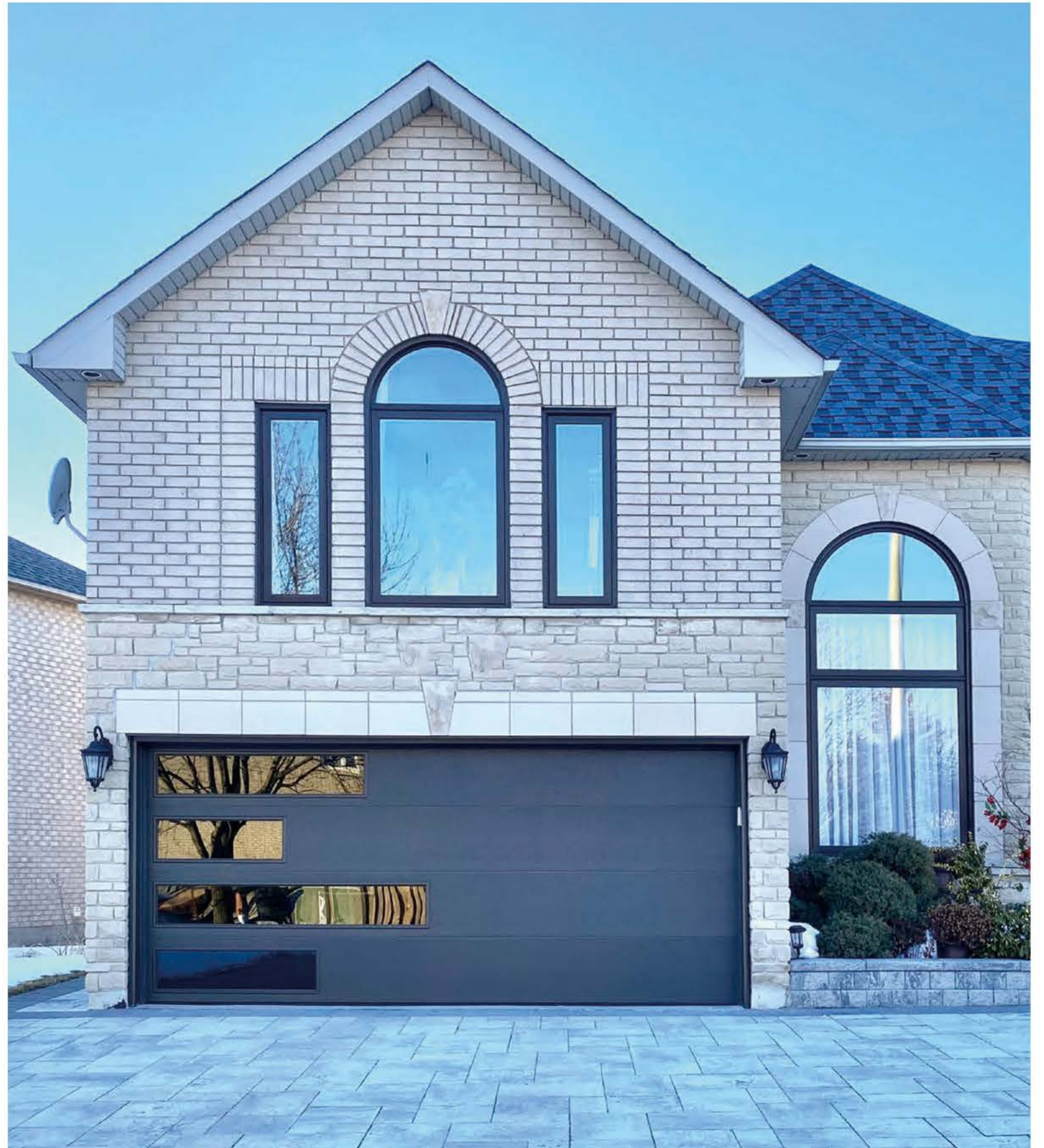



# Garage Door Options

## DOOR FEATURE ▶▶▶

### Door Metal

24-gauge hot dipped galvanized steel with two coat prefinished paint provide the durability of the color performance of your garage door.

### Door Construction

2" thickness sandwich panel with polyurethane foam injection in between of two steels provides superior strength. The tongue and groove meeting rails of each panel sections for better sealing against exterior materials.

### Door Parts

Heavy duty metal garage door hinges and tracks give strong support for the door.

### R-Value of 15.2 Insulation

Improve garage thermal efficiency, enhance energy saving and also reduce street noise.

### Warranty Door Section

10 years limited warranty on panels, and 3 years on garage door hardware.

## THE STYLE

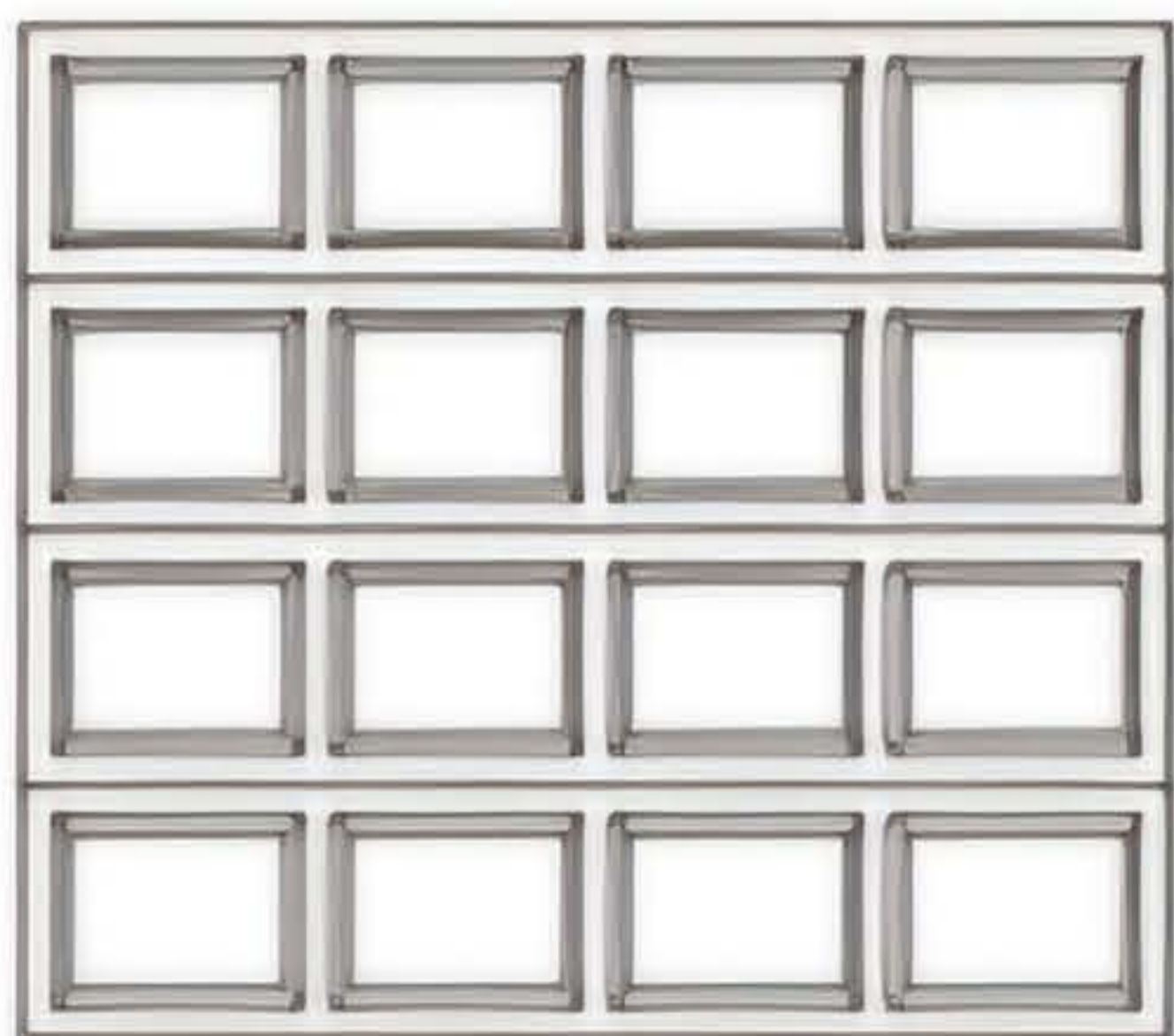

T100

T200



## COLOR \*



\*Metal colors may vary from location due to local climate in the painting process. Always request a color sample from your dealer for accurate color matching.

## WINDOW OPTIONS

### S01 Waterton



### S02 Cascade



### S03 Stockton



### S04 Piece Wagon Wheel

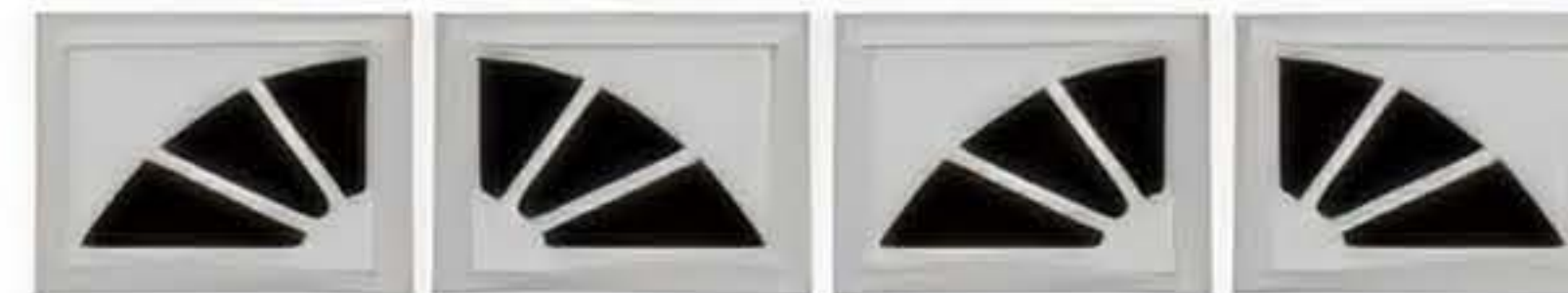

### S05 Piece Sunburst



## SIZE AVAILABLE

Door Wide	Door Panel
8'-9'	□ □ □ □
10'	□ □ □ □ □
12'	□ □ □ □ □ □
14'-15'	□ □ □ □ □ □ □
16'	□ □ □ □ □ □ □ □



# Garage Door Options

## DOOR FEATURE ▶▶▶

### Door Metal

Flush panel can be custom by cut window and filled with different glass.

24-gauge hot dipped galvanized steel with two coat prefinished paint provide the durability of the color performance of your garage door.

### Door Construction

2" thickness sandwich panel with polyurethane foam injection in between of two steels provides superior strength. The tongue and groove meeting rails of each panel sections for better sealing against exterior materials.

### Door Parts

Heavy duty metal garage door hinges and tracks give strong support for the door.

### R-Value of 15.2 Insulation

Improve garage thermal efficiency, enhance energy saving and also reduce street noise.

### Warranty Door Section

10 years limited warranty on panels, and 3 years on garage door hardware.

### THE STYLE FLUSH

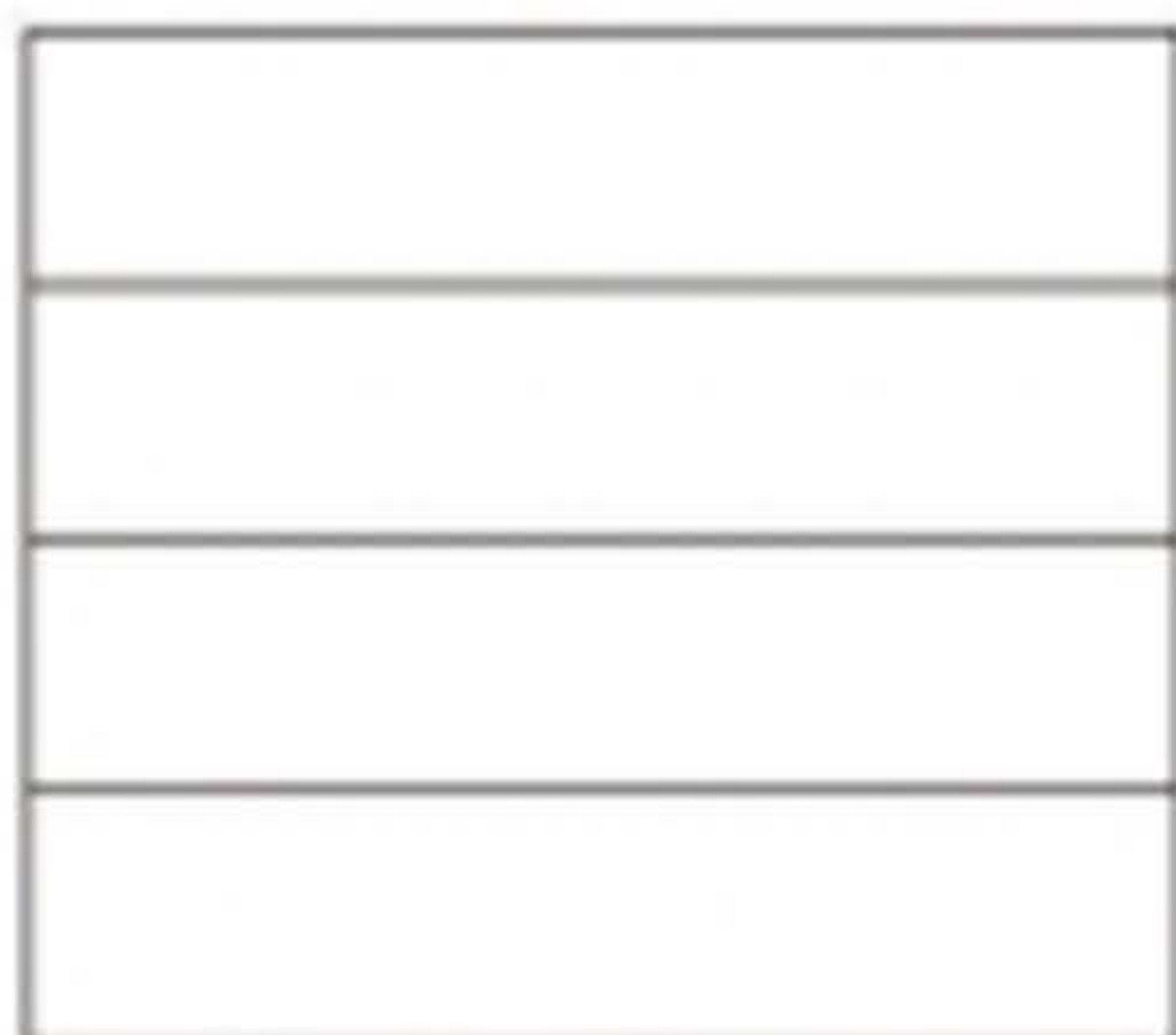

## COLOR \*



Actual colors may vary from brochure due to fluctuations in the printing process. Always request a color sample from your dealer for accurate color matching.

## STANDARD WINDOW CUTTING OPTIONS



## SPECIAL WINDOW CUTTING OPTIONS

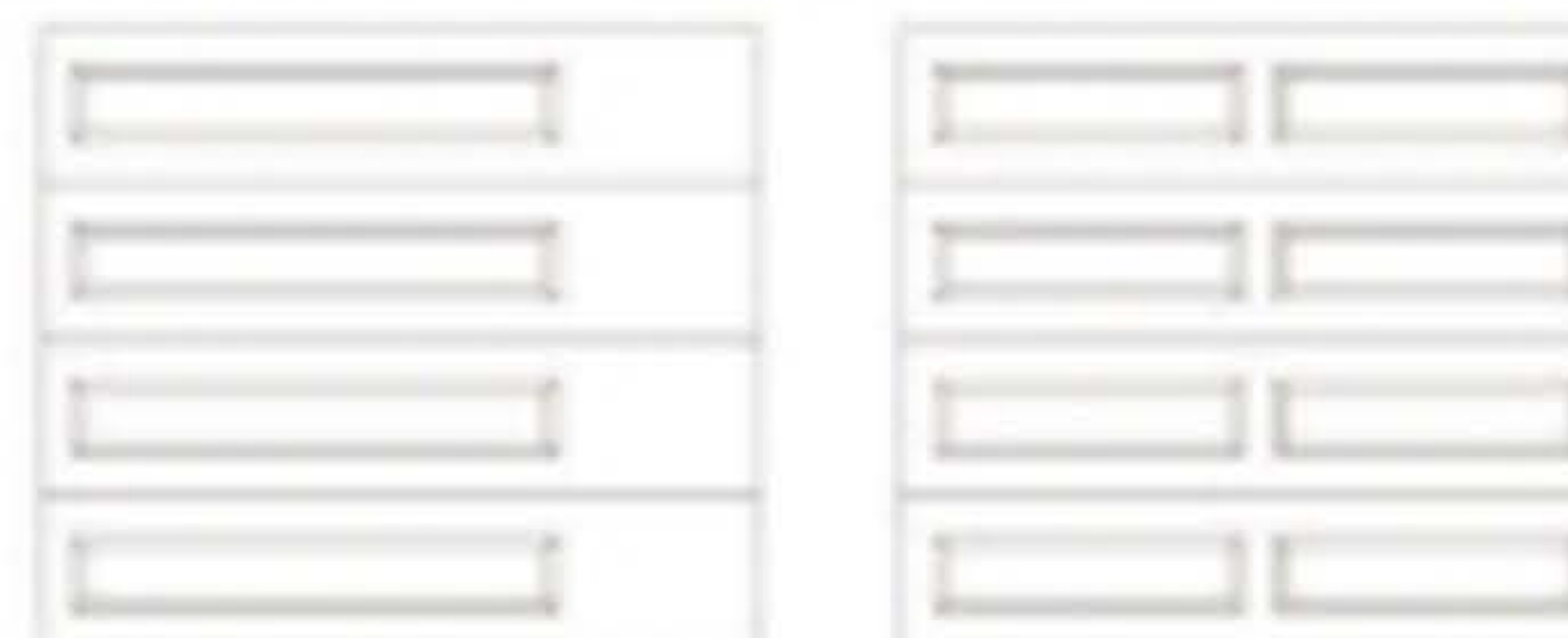



# NTI Warranty

Our objective is to keep things straightforward.  
Here's the warranty:

## General

1. The warranty includes full coverage of all parts and labor for 25 years on products, installation, and services provided by NTI Windows & Doors.

2. Warranty is Transferable

3. All products and their components are protected under this comprehensive warranty.

4. Installation is also warranted for the 25 years duration.

## **5. This Warranty does not cover:**

**A. Damage or defects resulting from misuse, abuse, alterations (including but not limited to customer-applied finishes), accidents, or break-ins are not covered.**

**B. Products affected by Extreme Weather Conditions**

**C. Products damaged due to structural shifting or settling.**

**D. Products that have been altered or damaged by other contractors or workers.**

**E. Frost accumulation or condensation caused by excessive indoor humidity levels.**

6. We Reserve the right to modify or discontinue any products we manufacture at our discretion. In the event of a warranty replacement, if exact replacement parts are unavailable, we may substitute components of an equal quality.

## After Installation Service

If you encounter any issues with a products or it's installation, please contact our office without hesitation. We will schedule an inspection promptly. Our goal is to have someone on-site within a week, though it may take up to two weeks in some cases. Certain services might require multiple visits. We are committed to keeping you updated throughout the process. Please note that we do not provide monetary compensation



## NTI Canadian Lifetime Warranty



In Canada, a 'lifetime' warranty is legally defined as 25 years, so for complete transparency, your NTI products are covered for that duration. This warranty provides lifetime coverage on all parts and labor related to products, installations, and services performed by NTI Windows & Doors. It's fully transferable with no paperwork required.

Please note, this warranty does not cover damages resulting from misuse, abuse, unauthorized alterations, break-ins, natural disasters, fires, structural changes to the building, work done by non-NTI professionals, or frost/condensation buildup caused by high interior humidity levels.

\*\*Garage Doors are Warrantied for 10 Years



Where Quality  
Meets Affordability

### CONTACT

appointments@ntiwindowsanddoors.ca  
905-512-2398  
ntiwindowsanddoors.ca



@ntiwindowsanddoors



@ntiwindowsdoors

